

Fig. 2

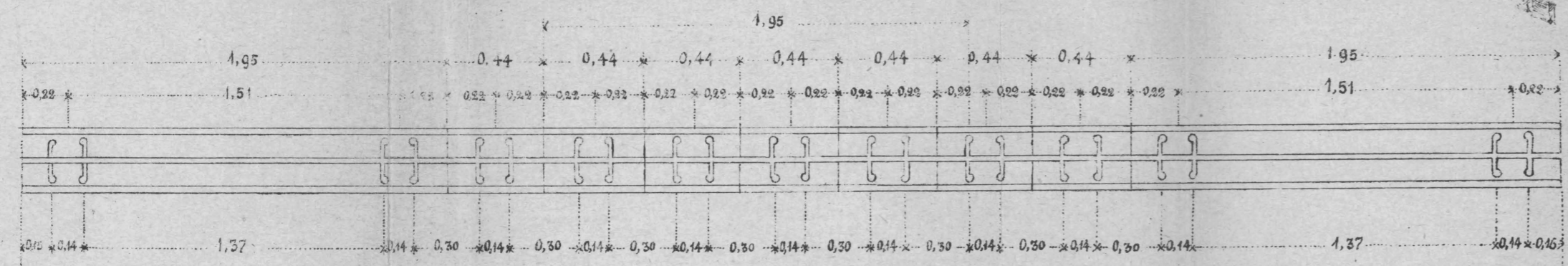

Fig. 3

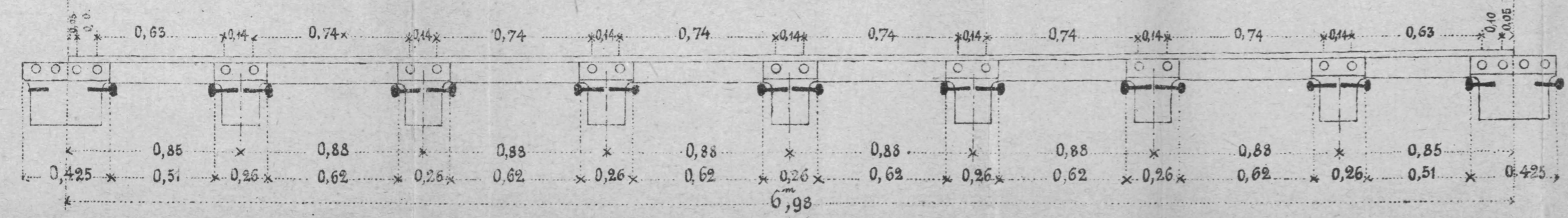

Fig. 4

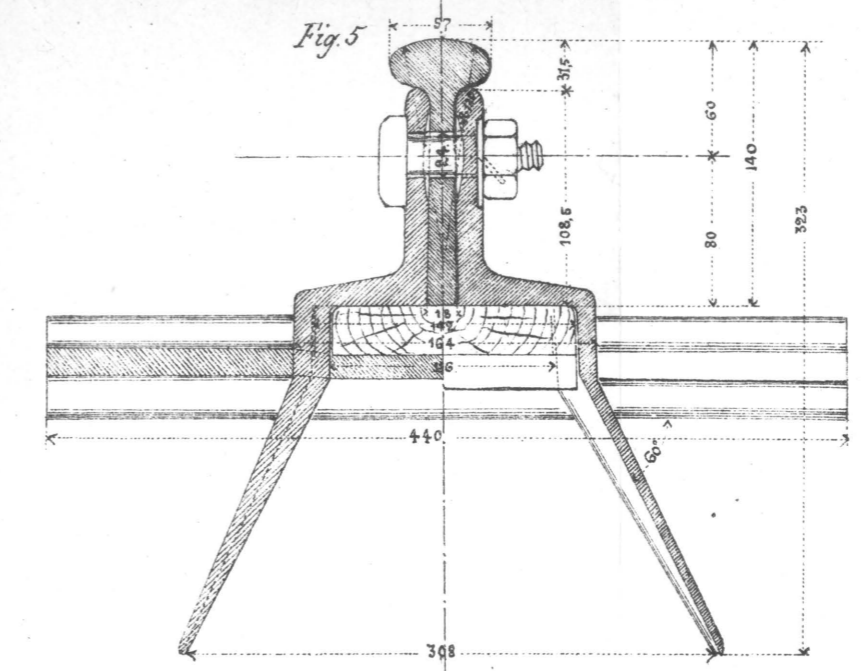
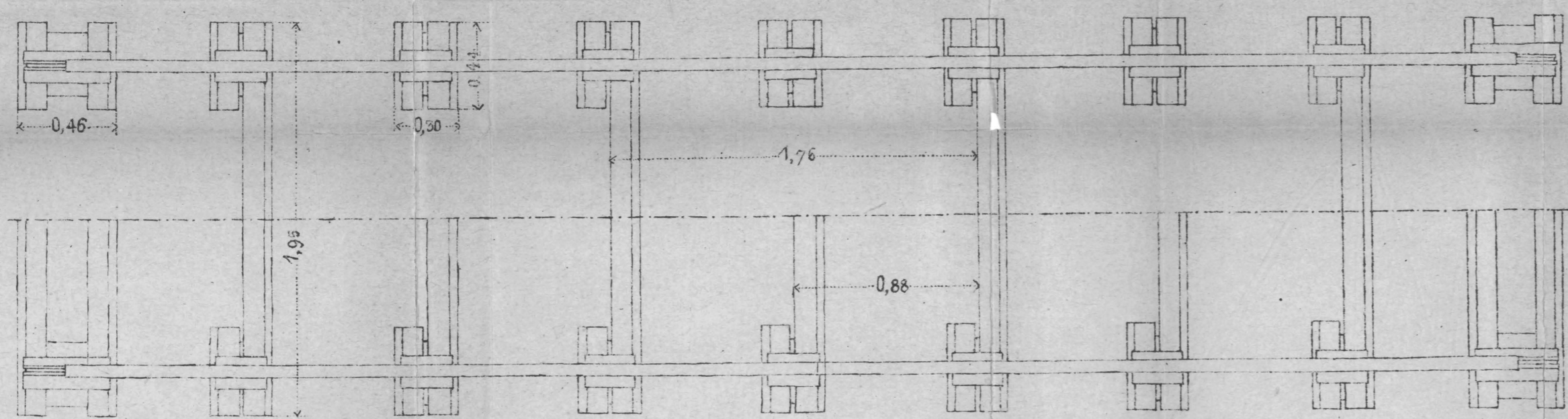

Fig. 6

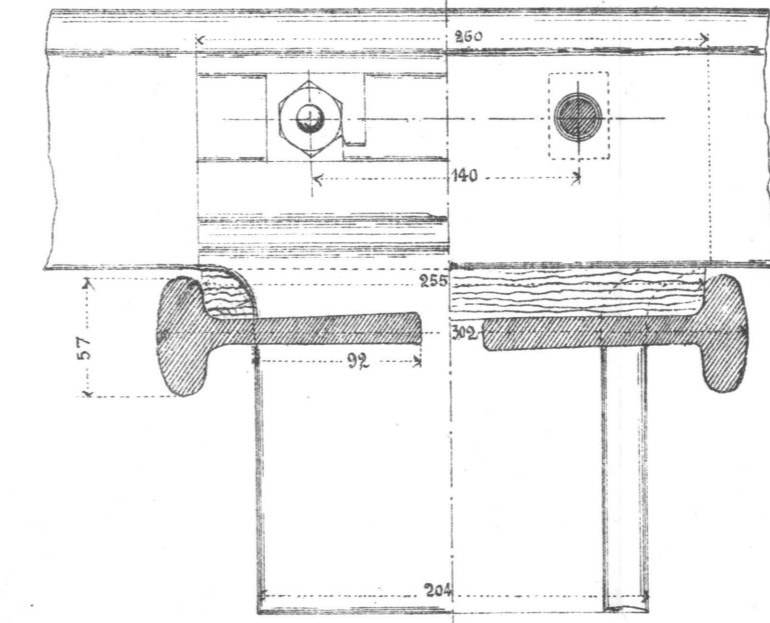

Fig. 9

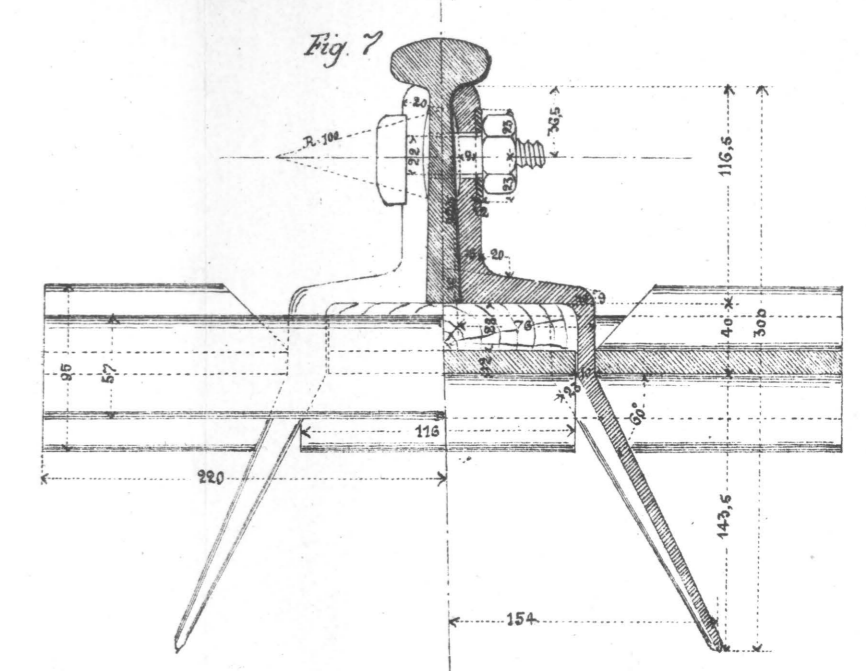
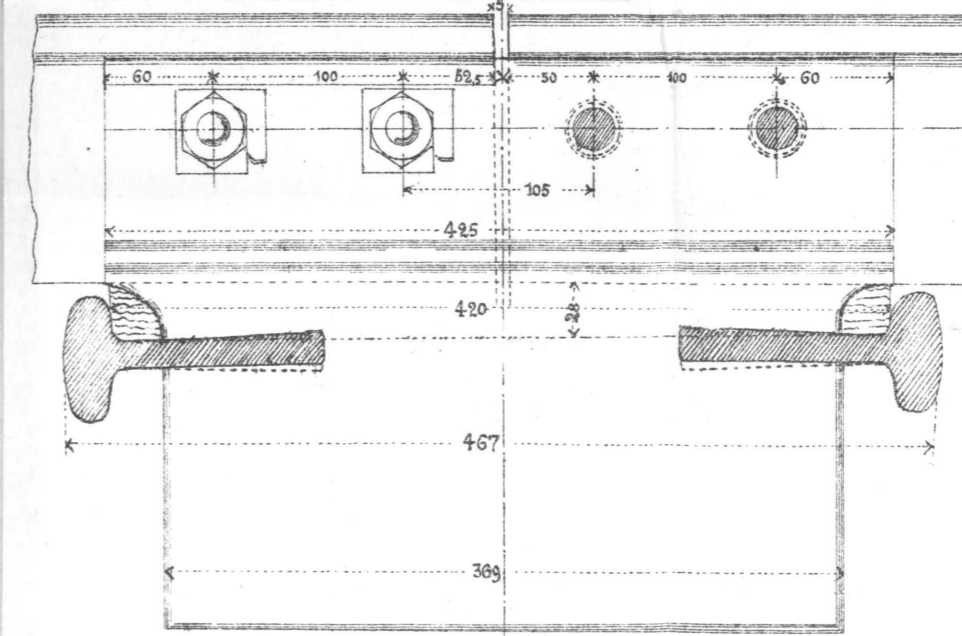

Fig. 8

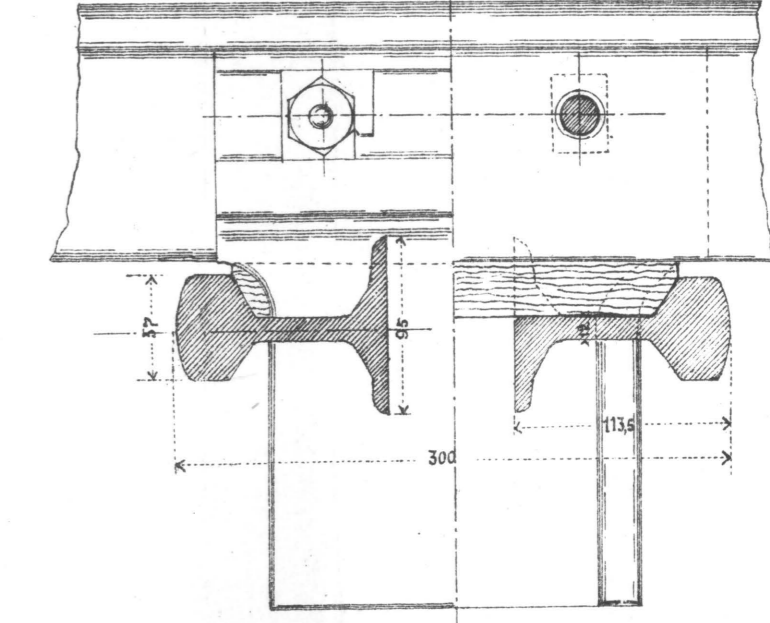
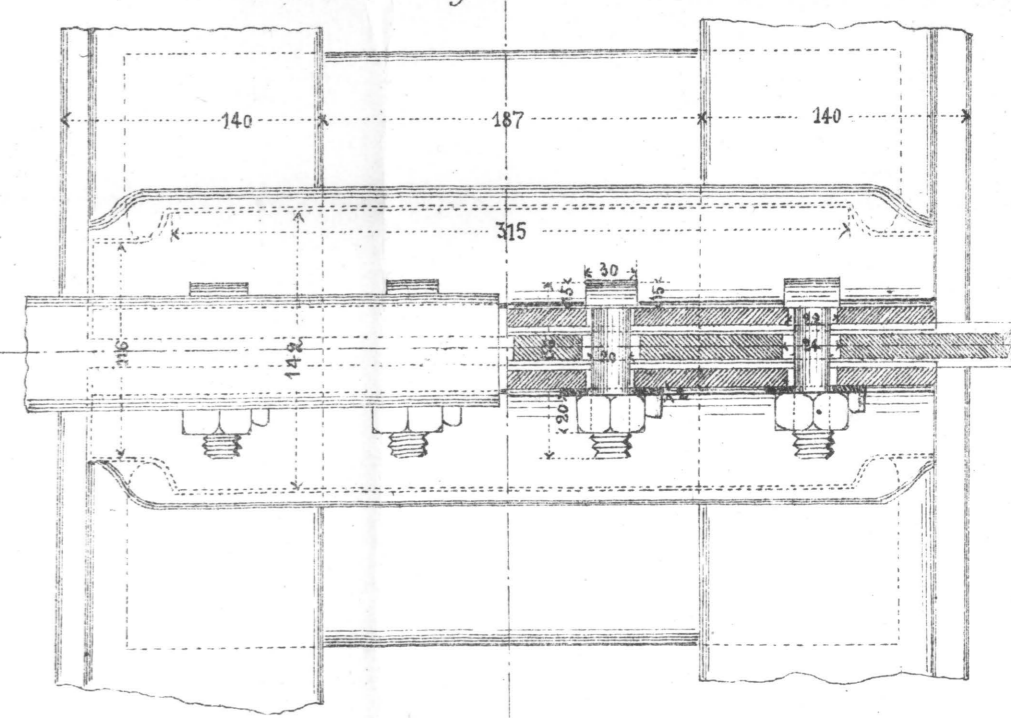
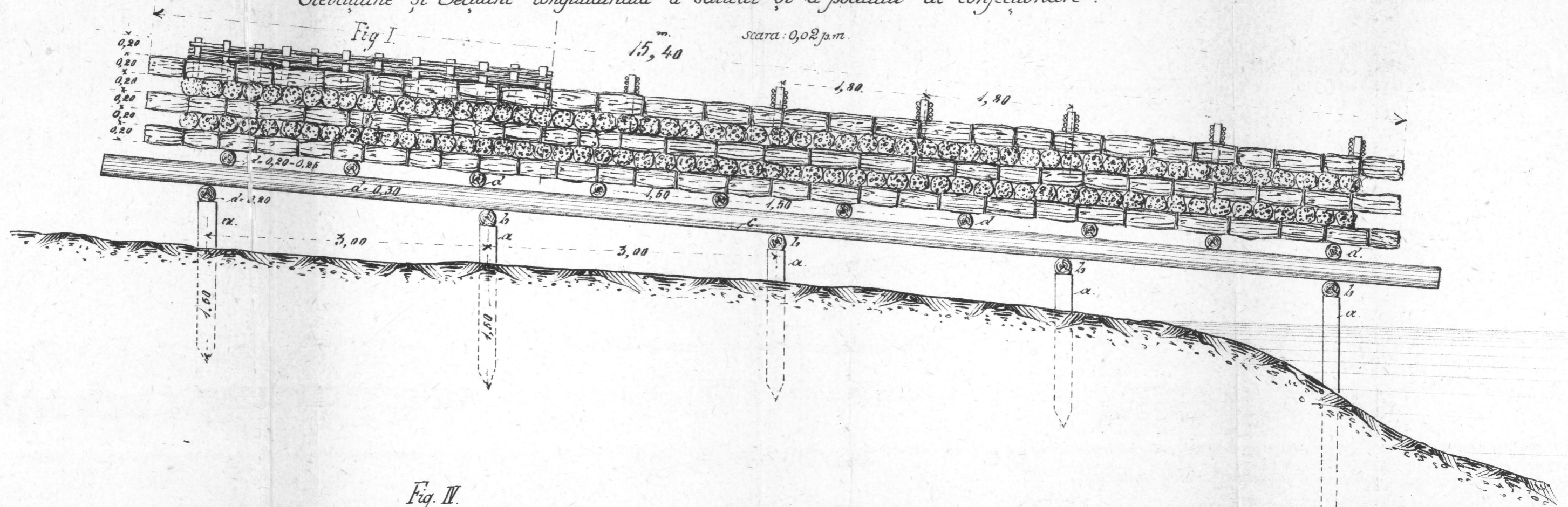

Fig. 10



*Saltele de fascine scufundate in fata queului Bechet.*

*Elevatiune și Sectiune longitudinala a saltelei și a podului de confectionare :*



*Fig. I.*

*Fig. III.*

*Sectiunea transversala.*

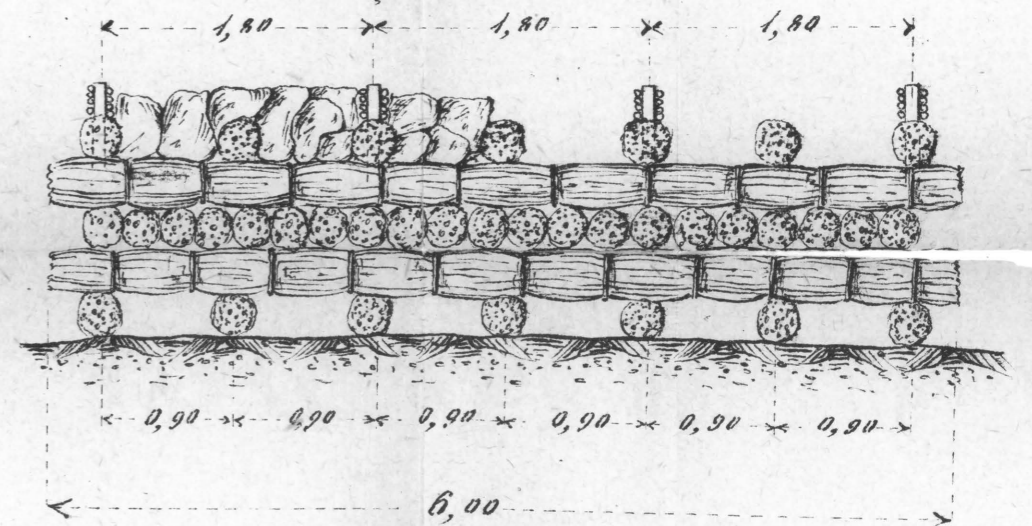

*Fig. V.*

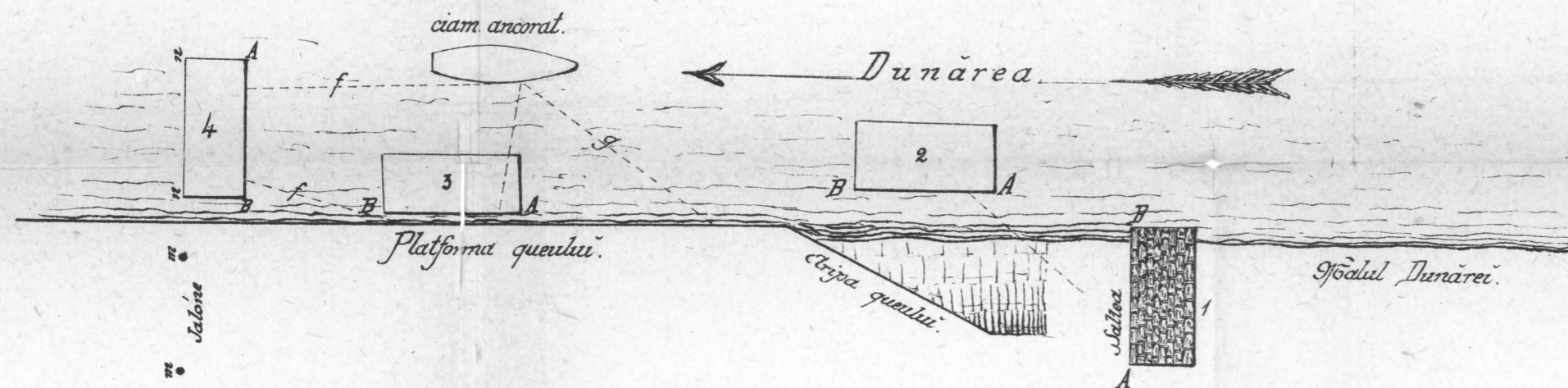

*Fig. II.*

*Fig. II.*

*Sectie transversala a podului.*

*Șoala trecerii frânghiei prin inelele dela colțuri.*

