



BULETINUL  
SOCIETATEI POLITECNICE

BIBLIOTECA DIR. D.  
Inventariat la poz. 950  
Anul 1937



ATLAS

1889

ROMANIA AUTONOMA C. F. R.  
Biblioteca Centrală  
No. 7950  
3



BUCURESCI  
TIPOGRAFIA CURTEI REGALE, **F. GÖBL FII**, PASSAGIUL ROMAN, 12,  
1890.

# LEGENDA



## I. Calea teledinamică Tîrgu-Ocna-Saline.

- 1) Plan de situație și profil în lung.
- 2) Stațiunea de încărcare, plan general, secții.
- 3) Stația de descărcare, plan general, secții.
- 4) Suportii laterali pentru șinele suspendate, manșoane pentru cablu de tracțiune, suportul acelor mobile, cusineți mobili și fixi pentru cablurile purtative.
- 5) Stațiunea de încărcare, planul compartimentului scripetelor, roata motrice a scripetelor.
- 6) Stațiunea de încărcare, secții longitudinale și transversale a compartimentului scripetelor.
- 7) Stațiunea de descărcare, secții transversale și în lung, declanșor pentru vagonete, cusineți pentru cablurile de tracțiune
- 8) Stațiunea de descărcare, plan.
- 9) Stațiunea de descărcare, secții transversale, cusineți pentru cablurile de tracțiune
- 10) Stațiuni intermediare, plan, secțiuni,
- 11) Aparatul de acuplare.

## II. Docurile din Galați și Brăila.

- 12) Profilul transversal al cheului la Dunărea, profilul transversal al Basinelui, planul basinului la Brăila

- 13) **III. Tablou grafic a vagoanelor acoperite, expediate încărcate și goale în anul 1888.**

## IV. Macara plutitoare de 40 tone.

- 14) Secții transversale și longitudinale.
- 15) Plan, secția orizontală.

## V. Calea ferată București-Fetești.

- 16) Tunelul din valea Mostiștea. — Plan de situație, planul tunelului, secții longitudinale și transversale. — Detalii.

## VI. Incercări la tracțiune cu tole de fer și oțel.

- 17) Curbe reprezentând variațiile de rezistență și lungire.

## VII. Cupola Ateneului Român din București.

- 18) Calculul grafic, diagrama fermelor.
- 19) Secția cupolei, plan general.
- 20) Secții transversale, planul fermelor.

## VIII. Turnul de 300 m. de la expoziția din Paris.

- 21) Diagramă, secții orizontale.

## IX. Pod peste Dunărea la Cernavoda.

- 22) Profil în lung, plan de situație, secție geologică.
- 23) Elevația generală a podului, plan.
- 24) Detaliuri de îmbinări a nodurilor.
- 25) Detaliuri de îmbinări a nodurilor.
- 26) Detaliuri de îmbinări a nodurilor.
- 27) Secția transversală prin montantul de 24 m. înălțime.
- 28) Construcția longeroanelor și a grinzilor transversale.
- 29) Aparatul de razăm suspendat.
- 30) Razemele pe pile și culee.
- 31) Pilele centrale, ansamblu și detalii.
- 32) Pilele laterale, ansamblu și detalii.
- 33) Culea Cernavoda, ansamblu și detalii.
- 34) Chesoanele pilelor centrale, plan, secții longitudinale.
- 35) Detaliile chesoanelor și a batardoului.
- 36) Proiectul modificat. — Elevație generală a podului și planul.

# CALEA TELEDINAMICA TIRGU OCNA-SALINE

96.

## PLAN DE SITUATIE

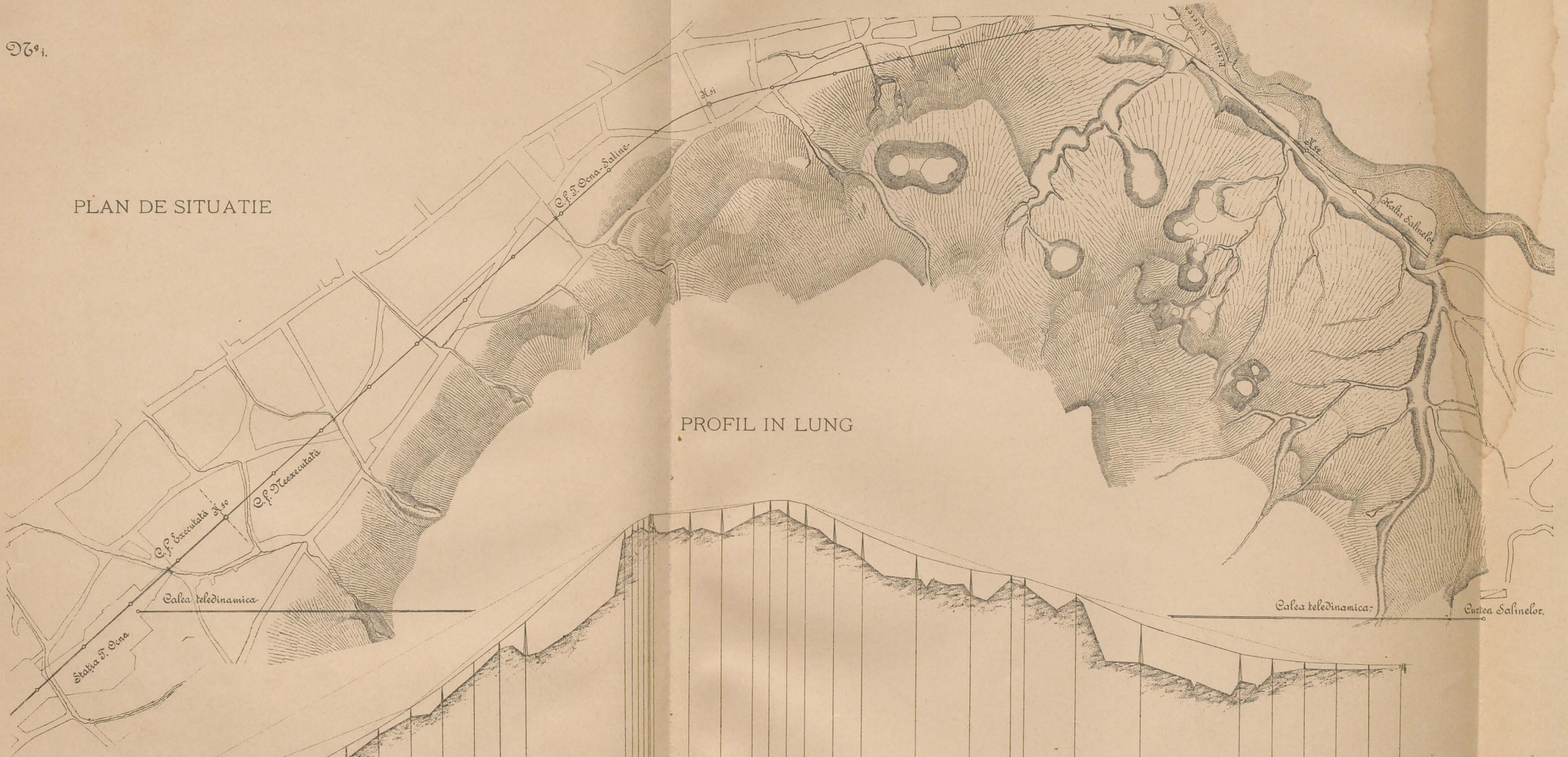

## PROFIL IN LUNG

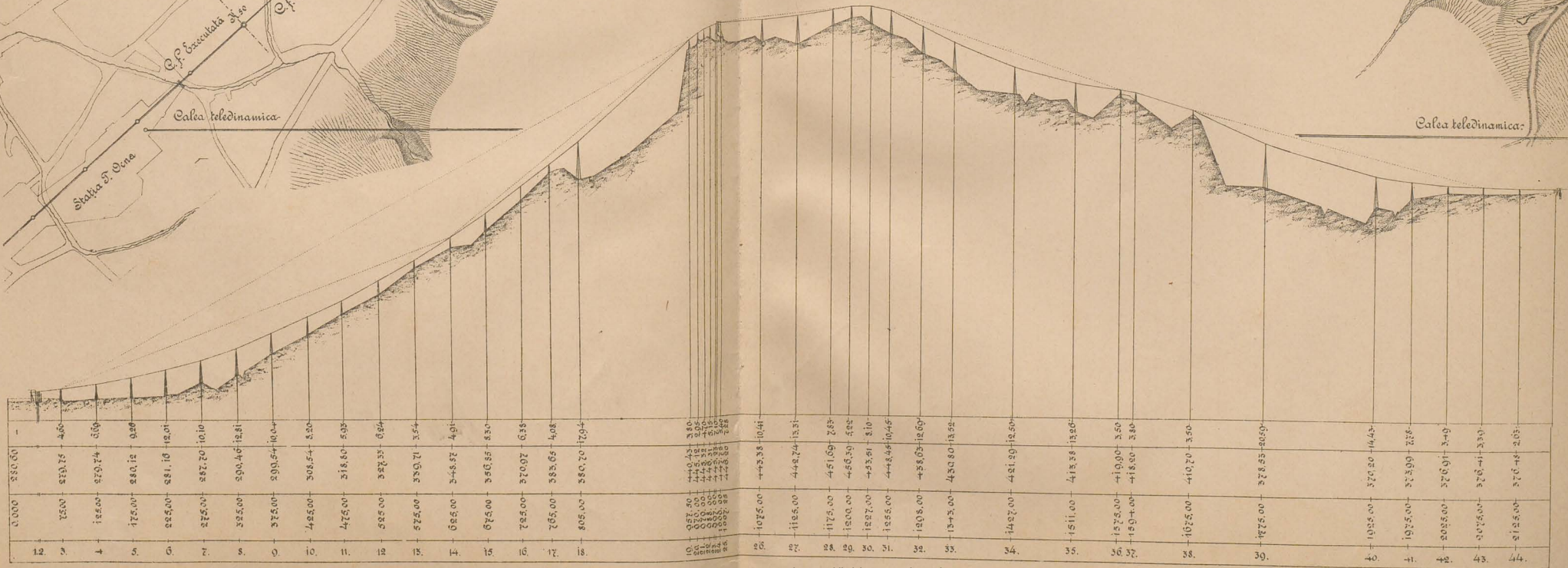

Inaltimea Stilpilor.  
 Cota terenului.  
 Distanța.  
 96 Stilpilor.

# CALEA TELEDINAMICA TIRGU OCNA-SALINE

№ 2. STATIUNEA DE INCARCARE

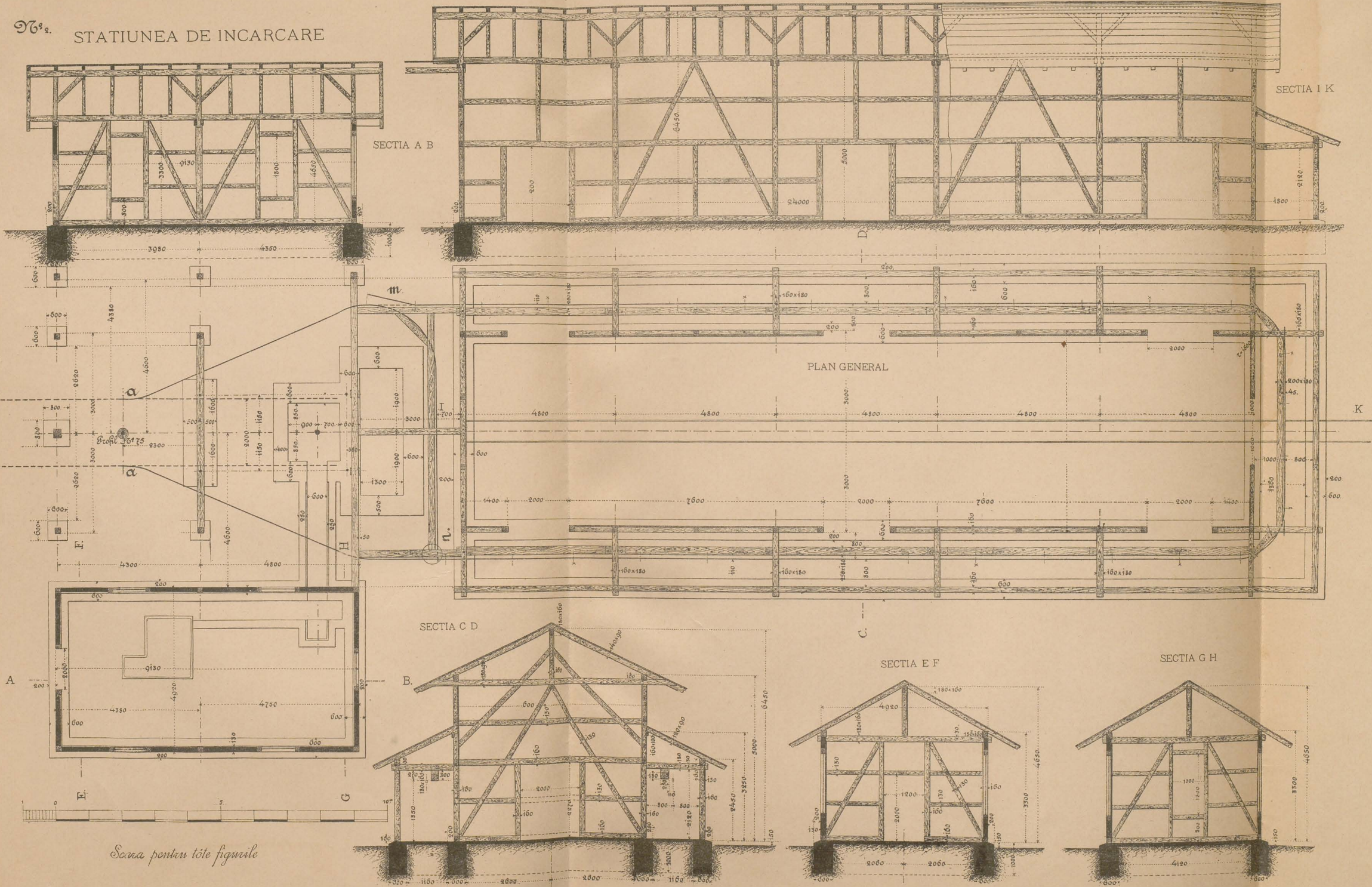

Scara pentru toate figurile

CALEA TELEDINAMICA TIRGU OCNA-SALINE

96° 3.

STATIUNEA DE DISCARCARE

CAPETELE ANCORATE ALE CABLURILOR PURTATOARE

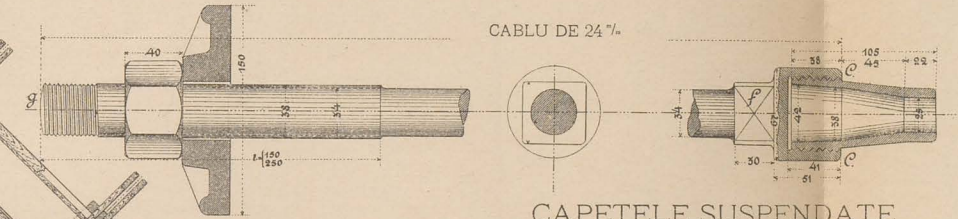
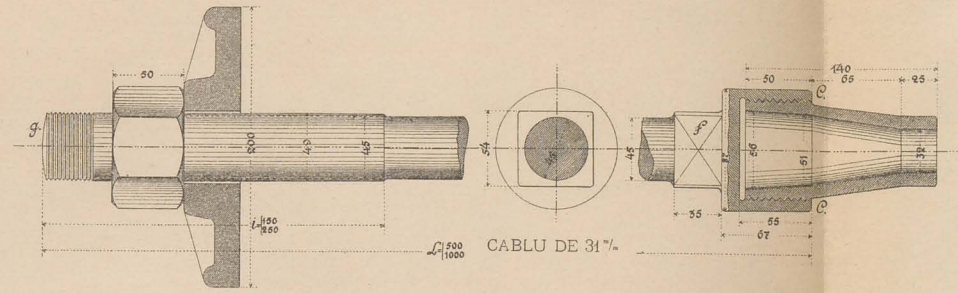
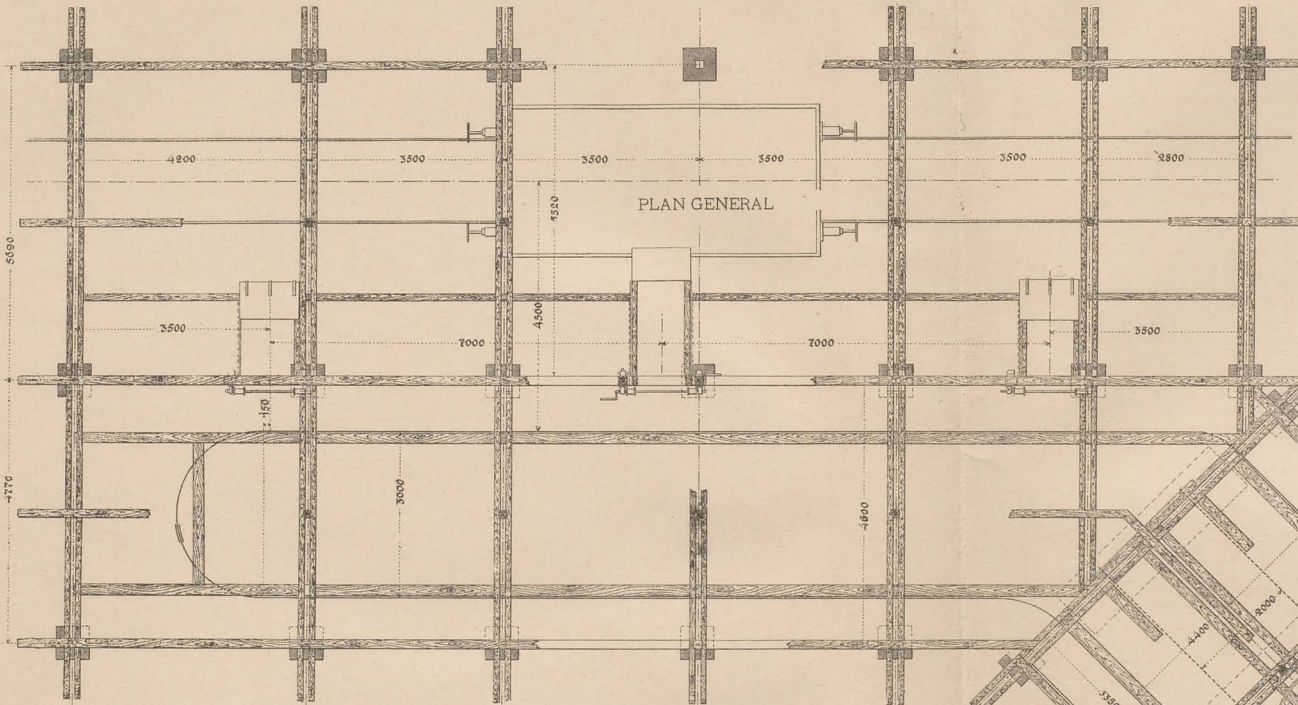

CAPETELE SUSPENDATE ALE CABLURILOR PURTATOARE

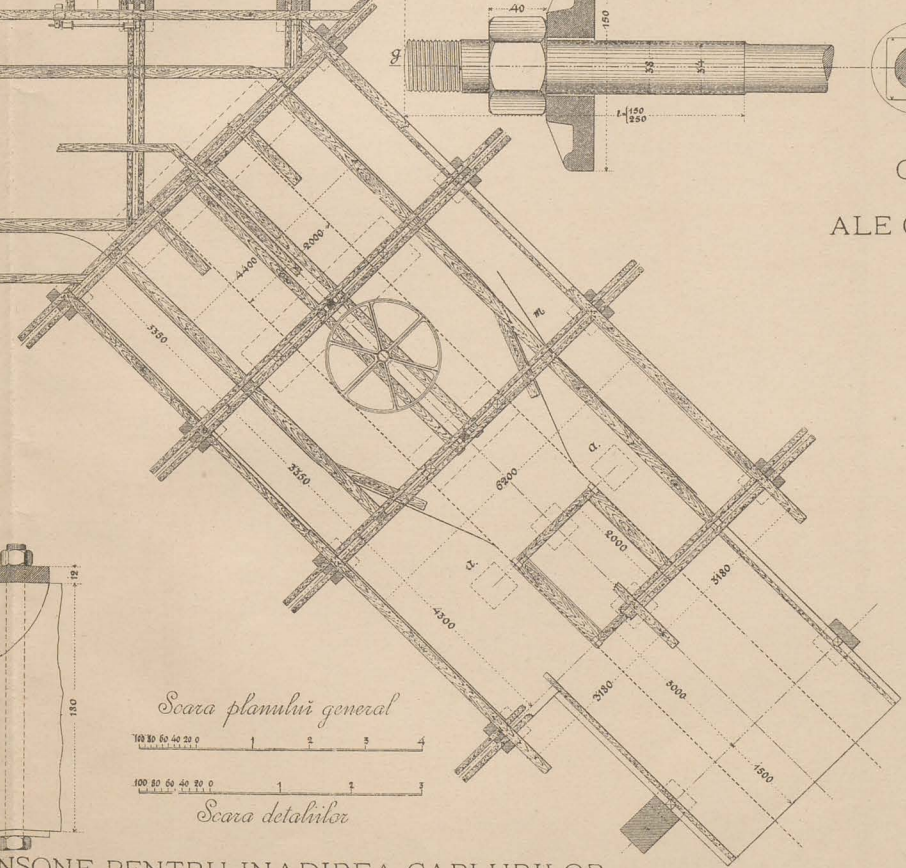
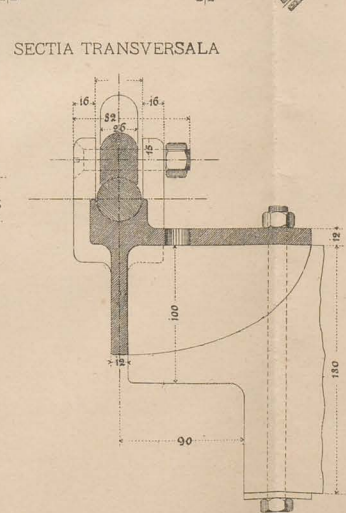
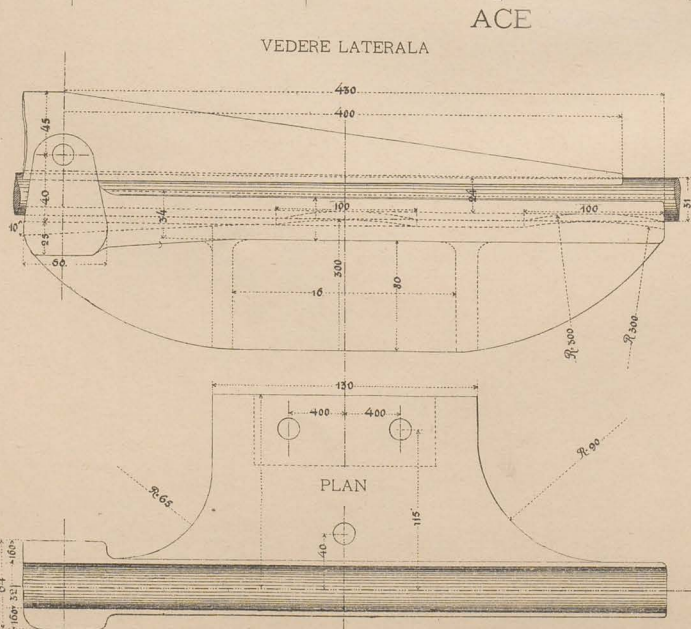
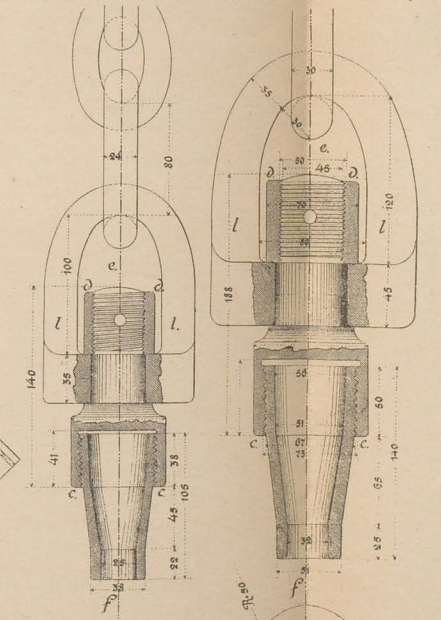

Scara planului general  
100 30 60 40 20 0 1 2 3 4

Scara detaliilor  
100 80 60 40 20 0 1 2 3

MANSONE PENTRU INADIREA CABLURILOR

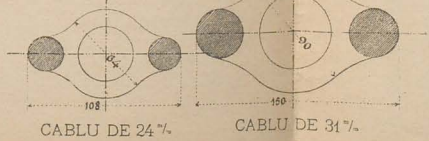
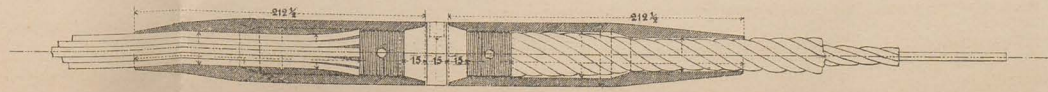

# CALEA TELEDINAMICA TIRGU OCNA-SALINE

Nº 4.

## SUPORT LATERAL PENTRU ŞINE SUSPENDATE

VEDERE DIN FATA

VEDERE LATERALA

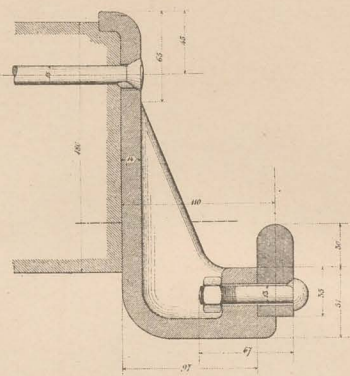
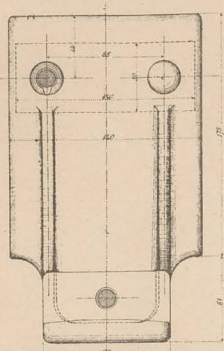

SECTIA A B

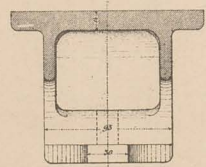

VEDERE LATERALA

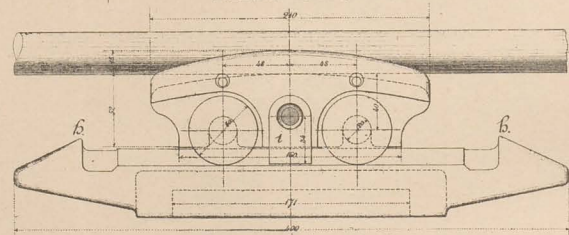

PLANUL VAGONETULUI

Cablu de 31<sup>mm</sup>

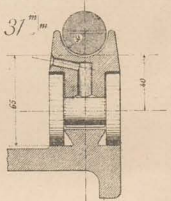

CUSINETI MOBILI

Cablu de 24<sup>mm</sup>

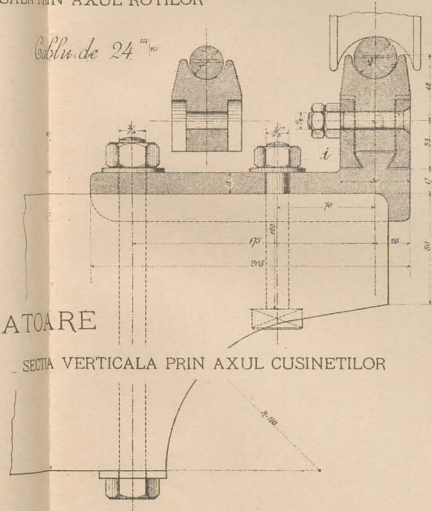

SECTIA VERTICALA PRIN AXUL CUSINETILOR

PENTRU CABLURILE PURTATOARE

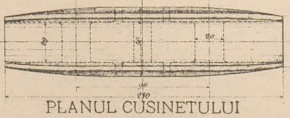

PLANUL CUSINETULUI

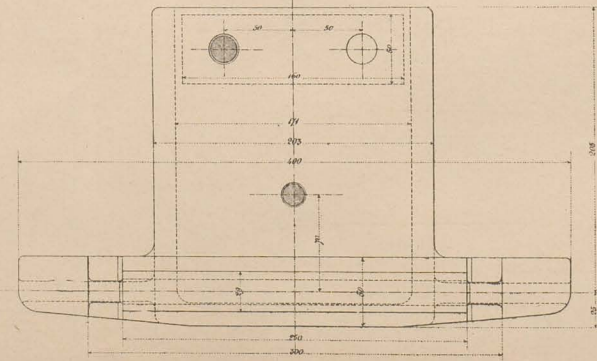

Scara pentru toate figurile

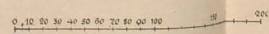

## SUPORTUL ACELOR MOBILE

VEDERE DIN FATA

VEDERE LATERALA

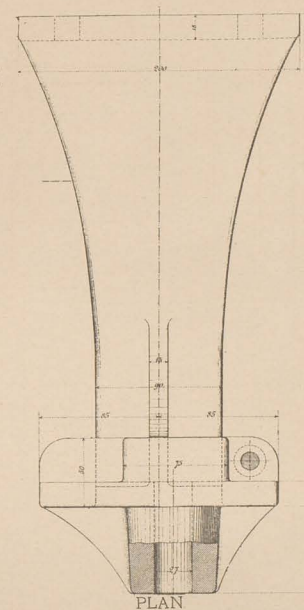

PLAN

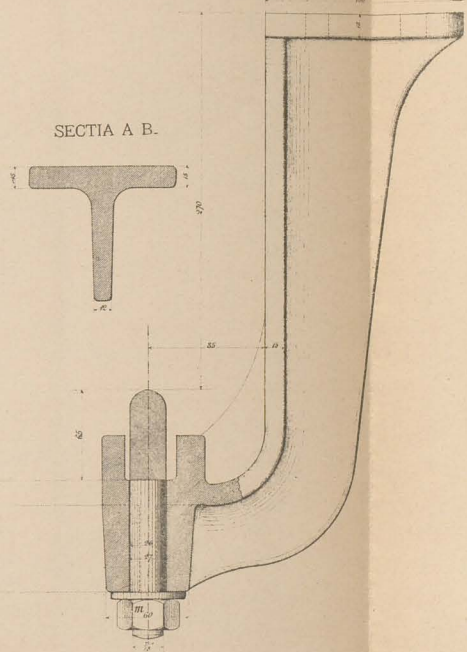

SECTIA A B

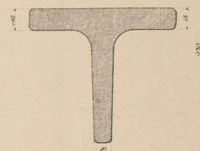

ACE MOBILE

VEDERE DIN FATA



Scara 0 100 200 300 400 500 600 700 800 900 1,000

## CUSINETI FIXI PENTRU CABLURILE PURTATOARE

CABLU DE 31<sup>mm</sup>

CABLU DE 24<sup>mm</sup>



Sectii in lung

Plan

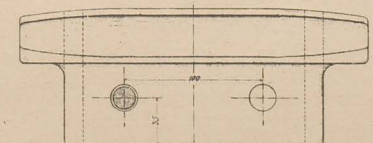

Sectia transversala

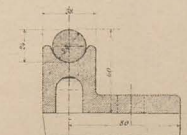

Plan

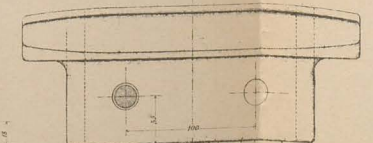

# CALEA TELEDINAMICA TIRGU OCNA-SALINE

Nº 5.

## STATIUNE DE INCARCARE

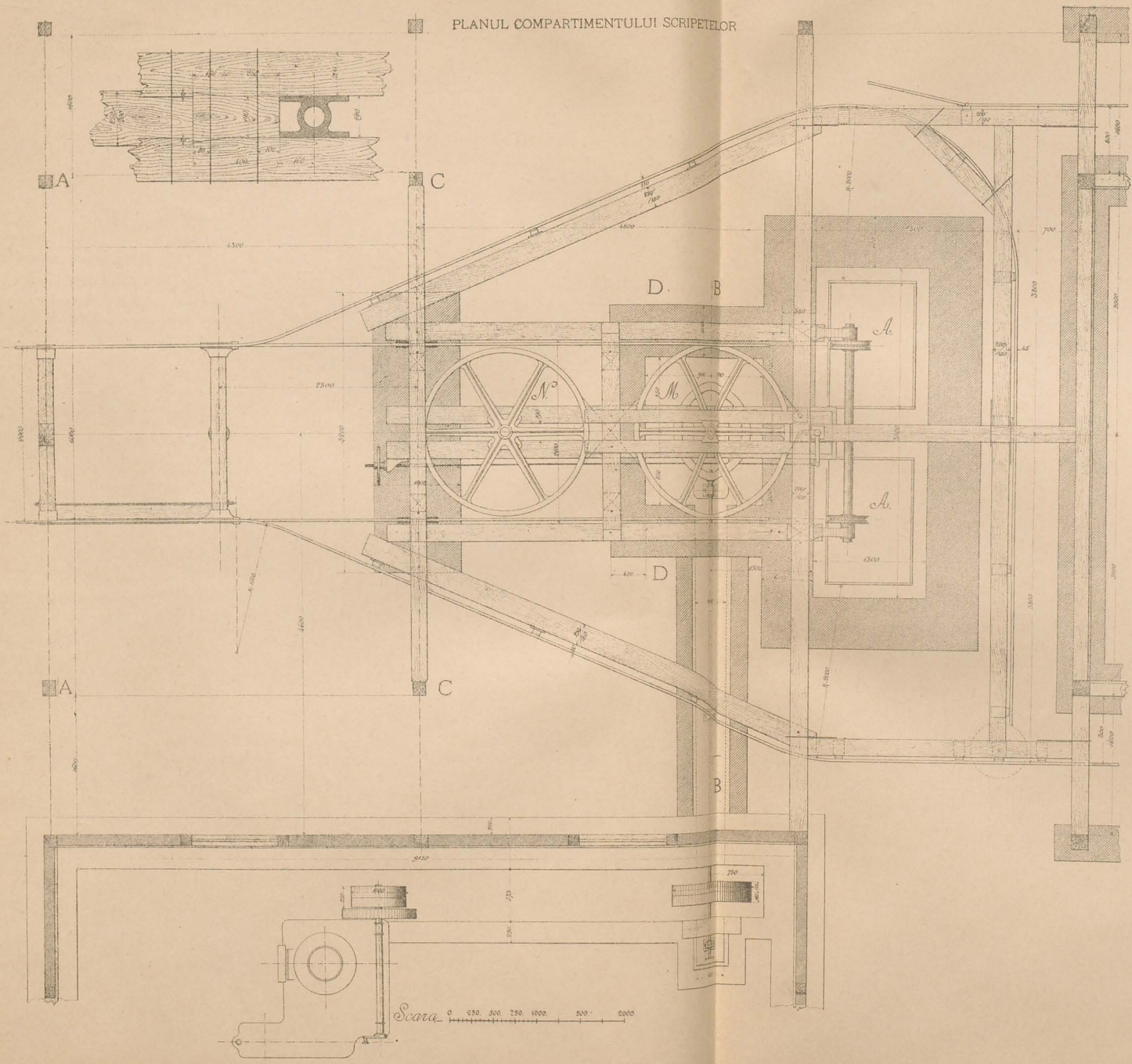

## ROTA MOTRICE A SCRIPETELOR CU AXUL SEU

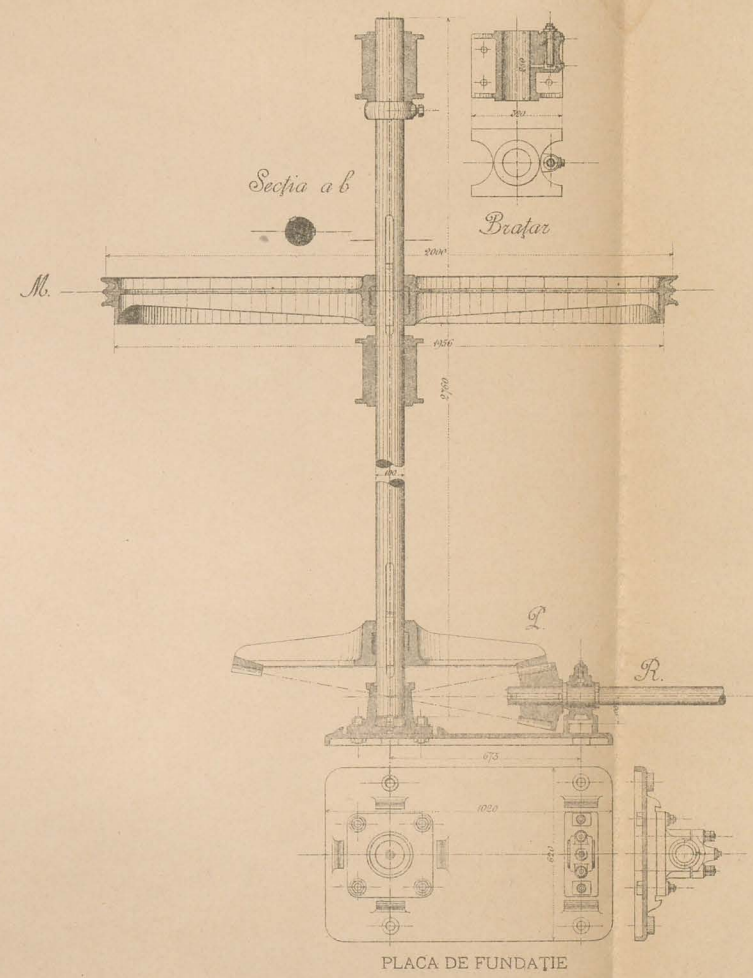

## FRANA ROTEI MOTRICE

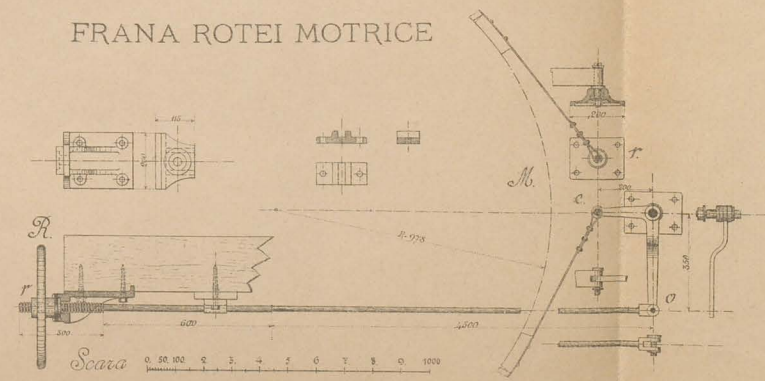



# CALEA TELEDINAMICA TIRGU OCNA-SALINE

Nº 5.

## STATIUNE DE INCARCARE

## ROTA MOTRICE A

PLANUL COMPARTIMENTULUI SCRIPETELOR

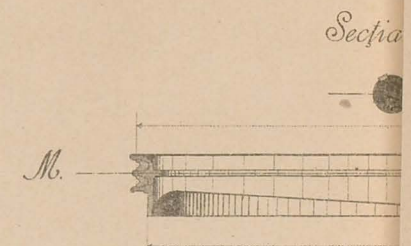
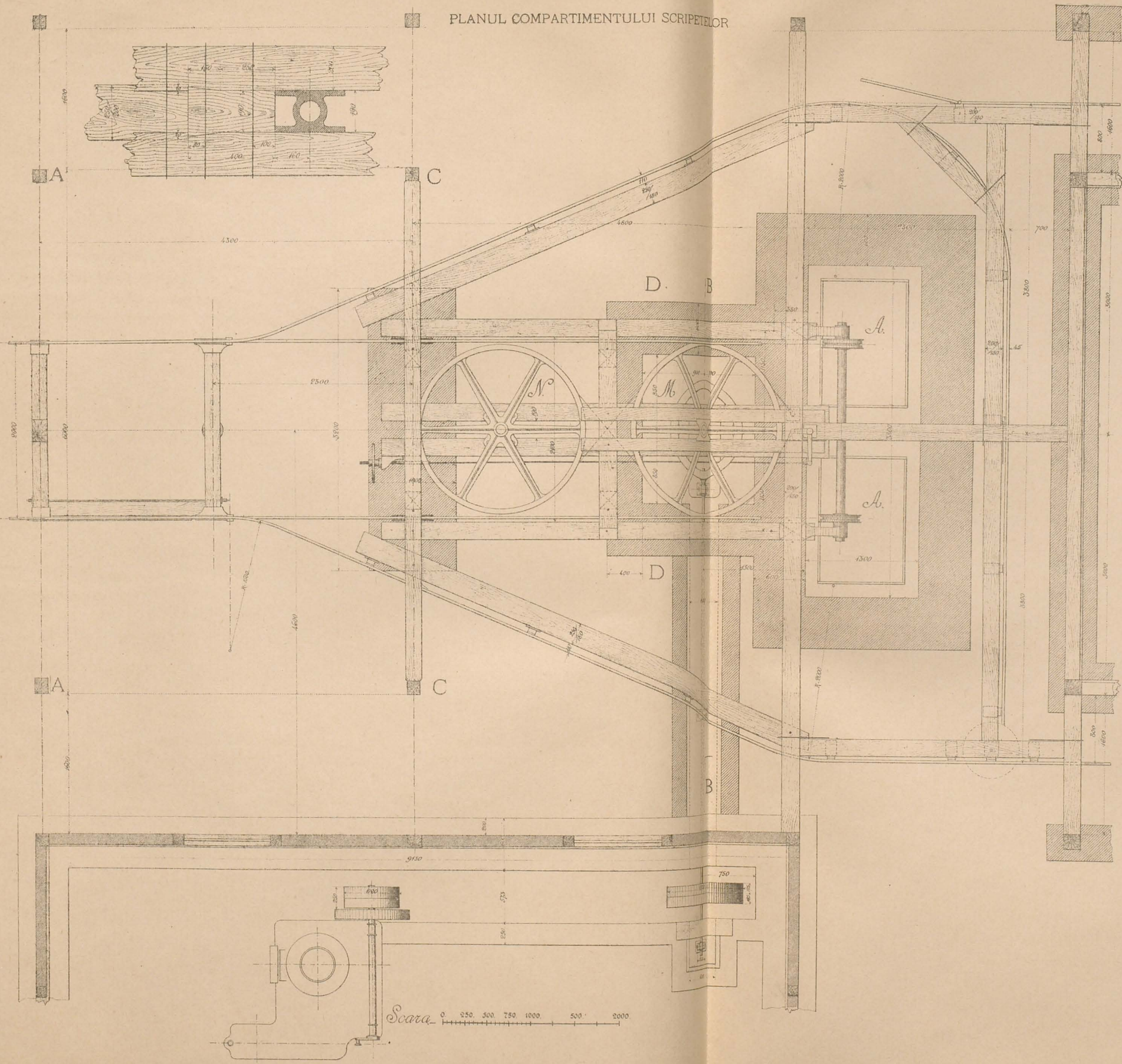

## FRANA ROTEI M

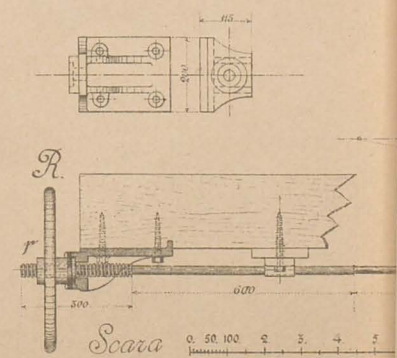

Scara 0 250 500 1000 500 2000

Scara 0 50 100 2 3 4 5

REGIA AUTONOMĂ G. F. R.  
Biblioteca Centrală  
No. \_\_\_\_\_

# CALEA TELEDINAMICA TIRGU OCNA-SALINE

No. 6.

## STATIUNE DE INCARCARE

SECTIA LONGITUDINALA A COMPARTIMENTULUI SCRIPETELOR

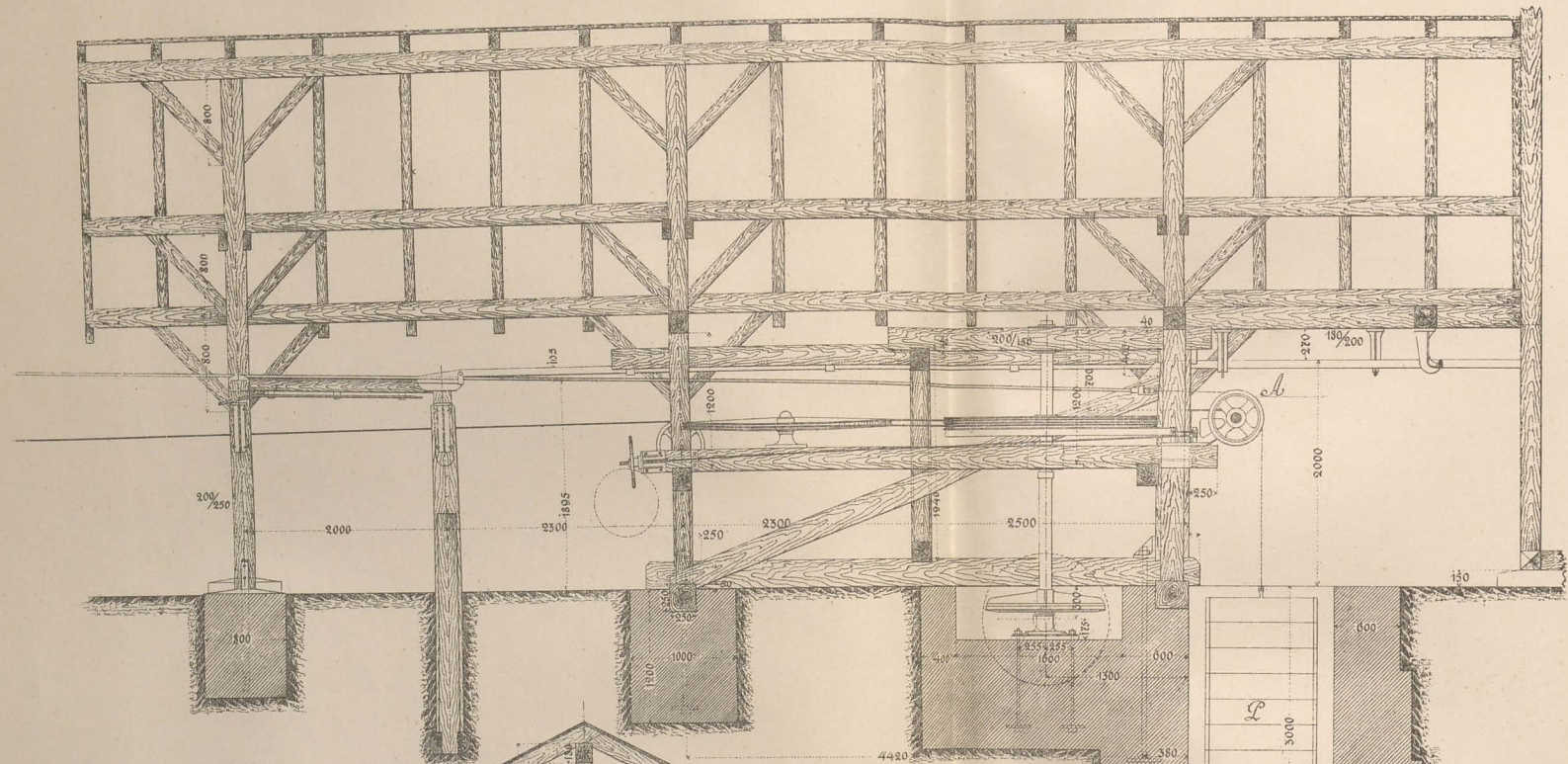

SECTIA A

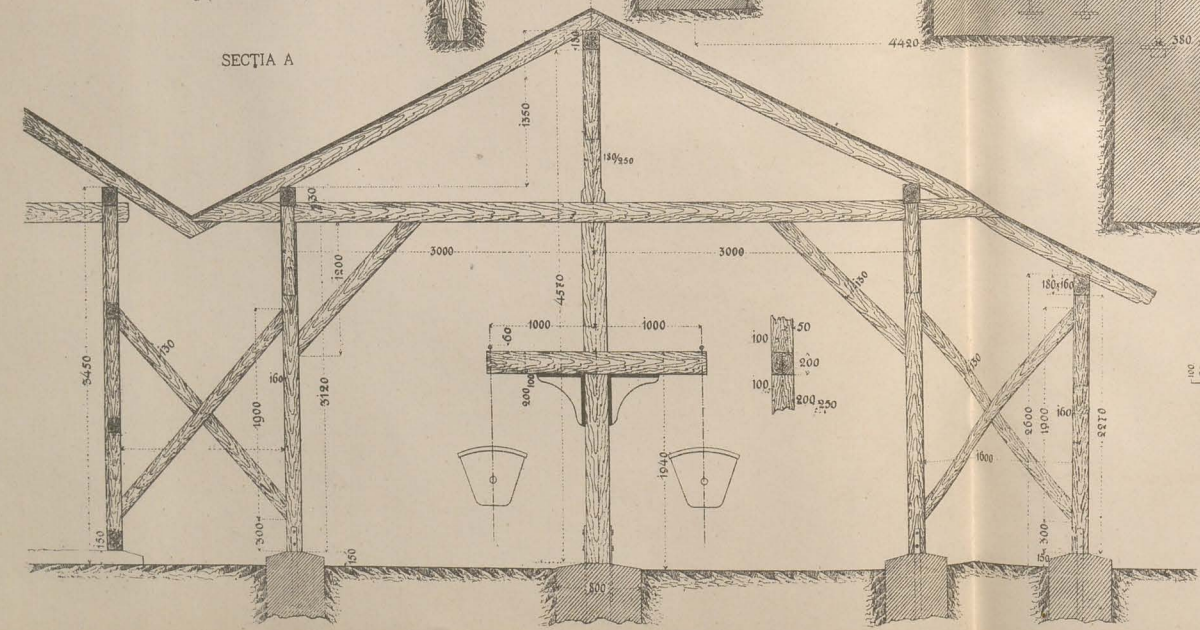

SECTIA C

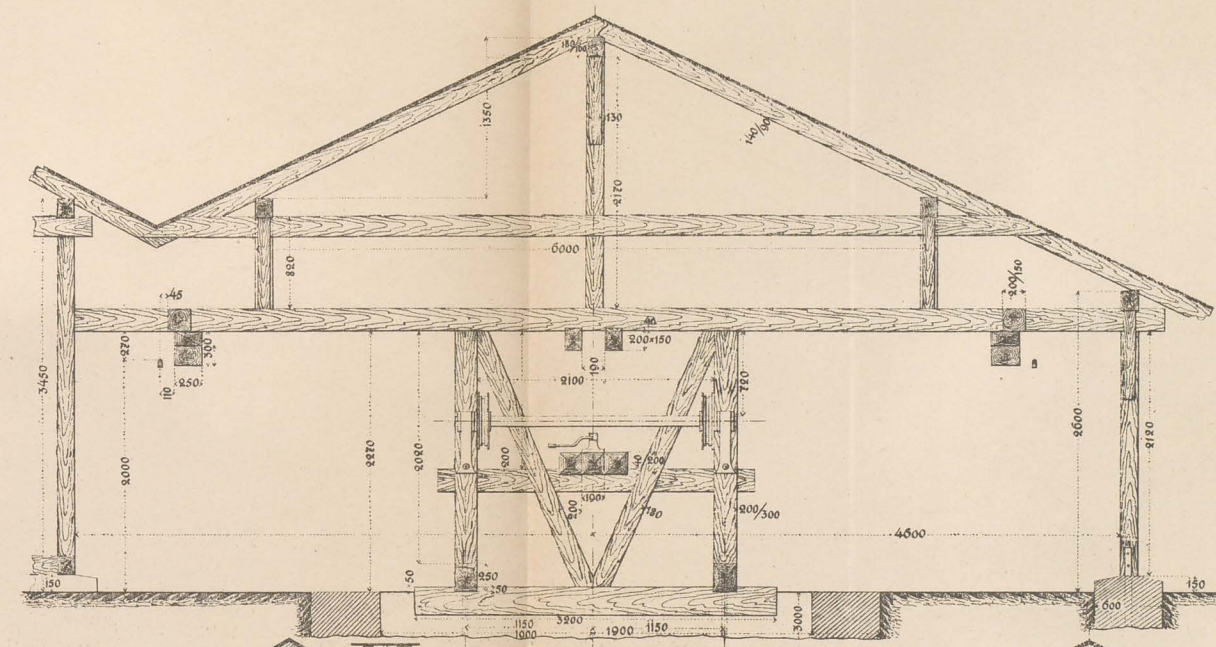

SECTIA D

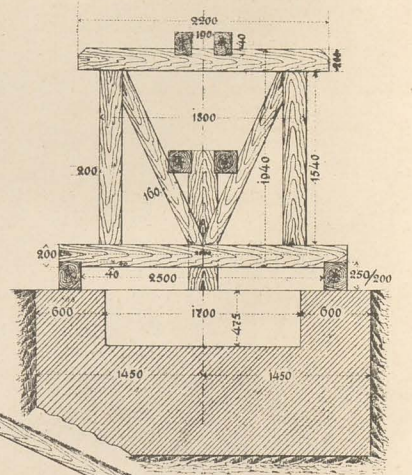

SECTIA B

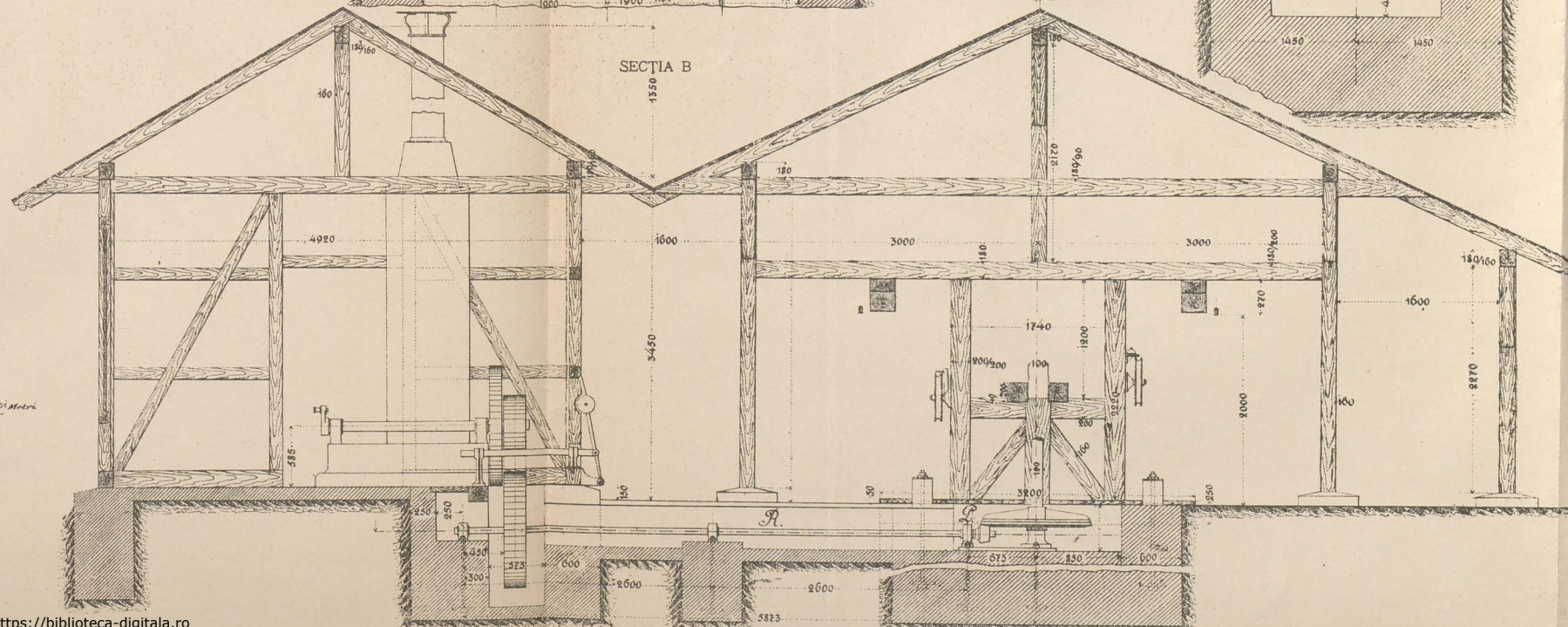

Scara pentru lăte figurile

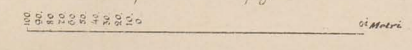

# CALEA TELEDINAMICA TIRGU OCNA-SALINE

## STATIUNEA DE DISCARCARE

### SECTIA IN LUNG PARALELA CU CABLUL

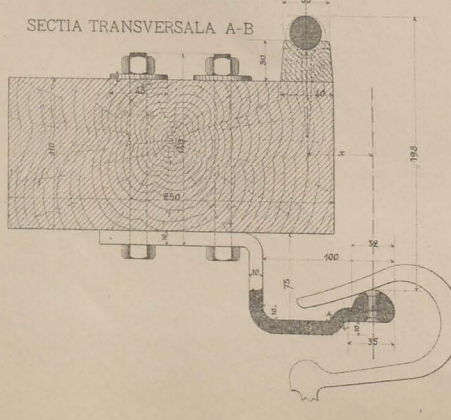
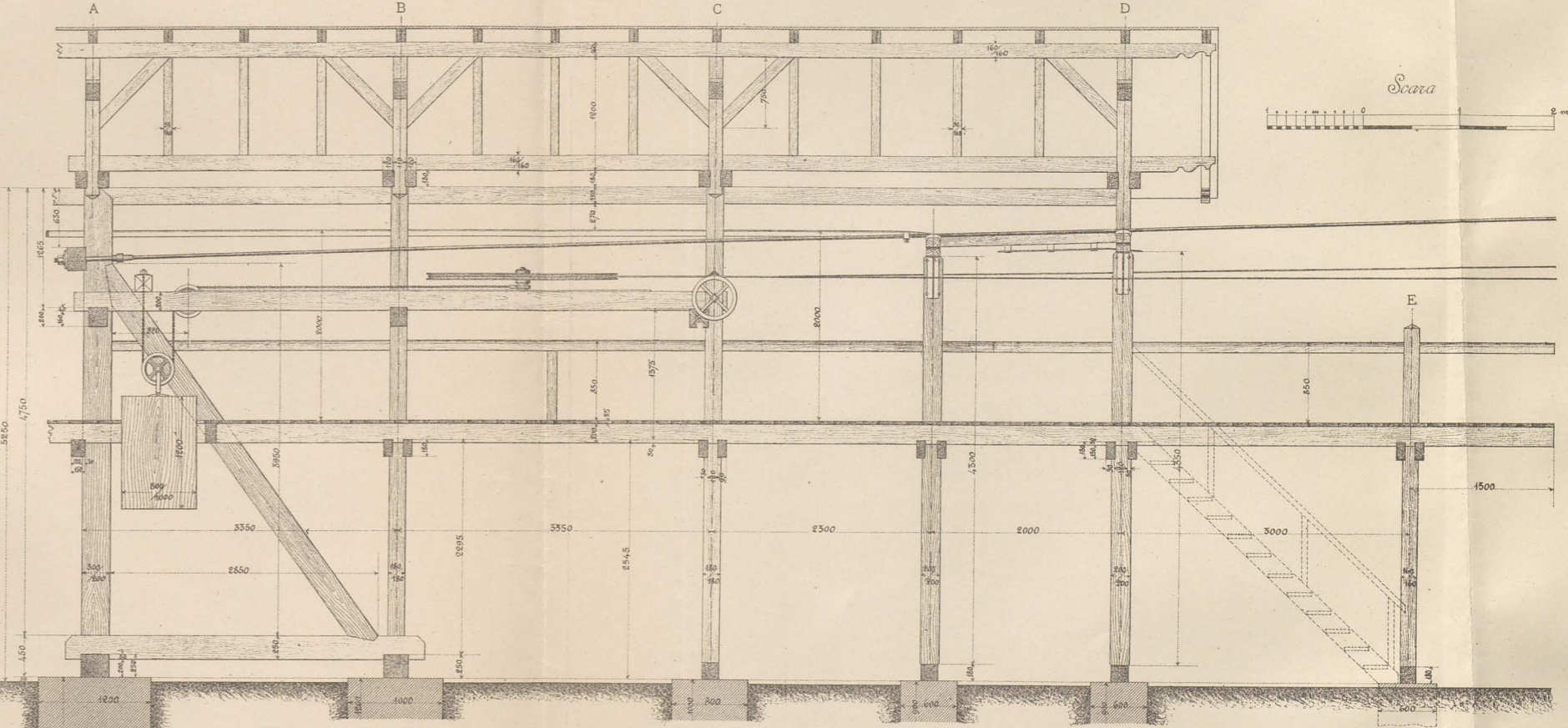
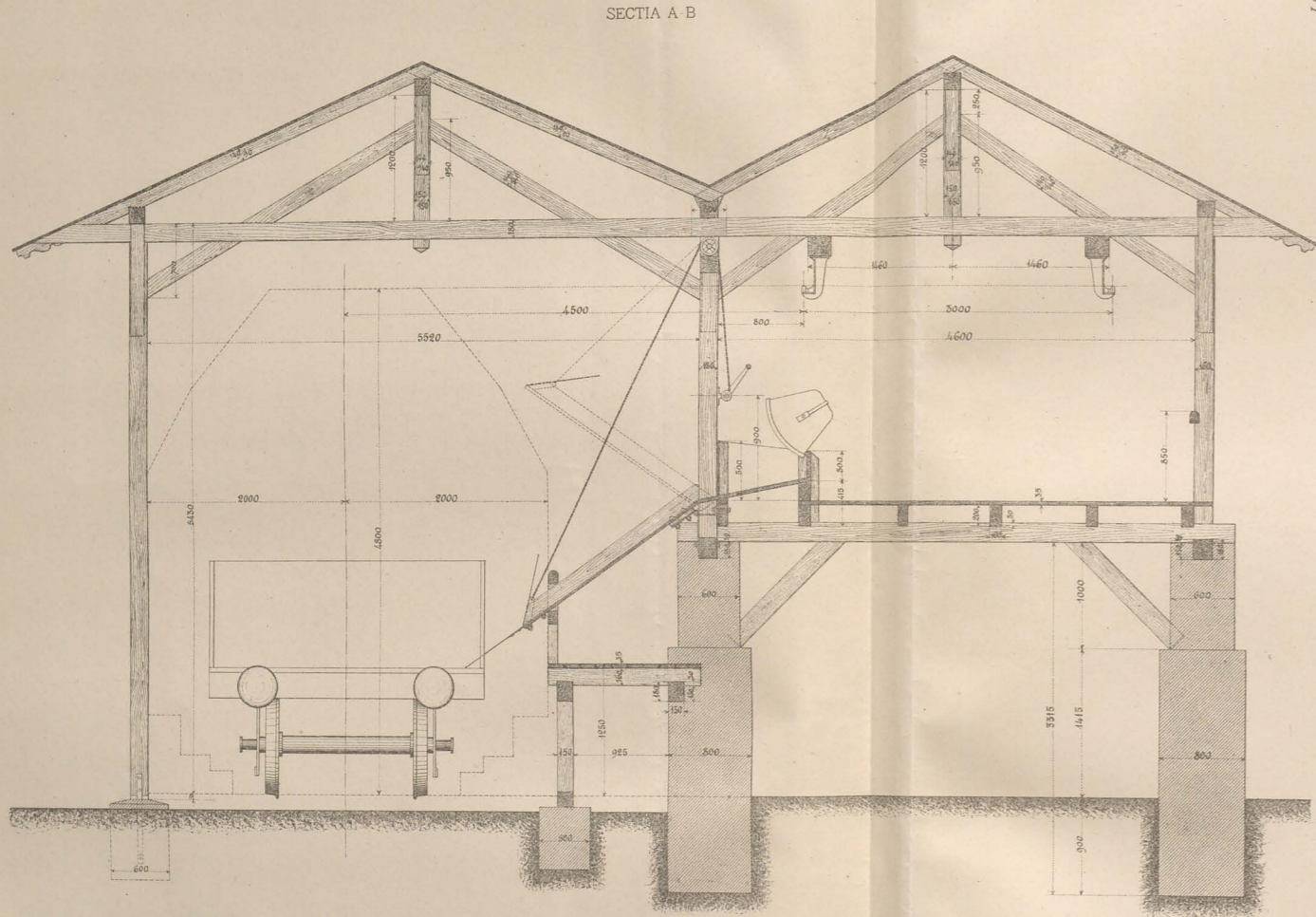

### DECLANSOR PENTRU VAGONETE

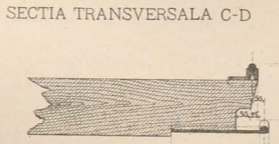
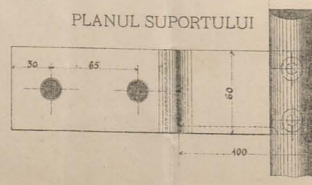
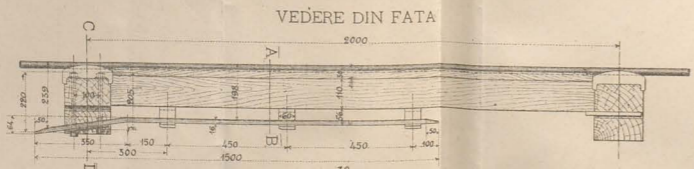

### CUSINETI CU CILINDRE PROFILATE PENTRU CABLURILE DE TRACTIUNE

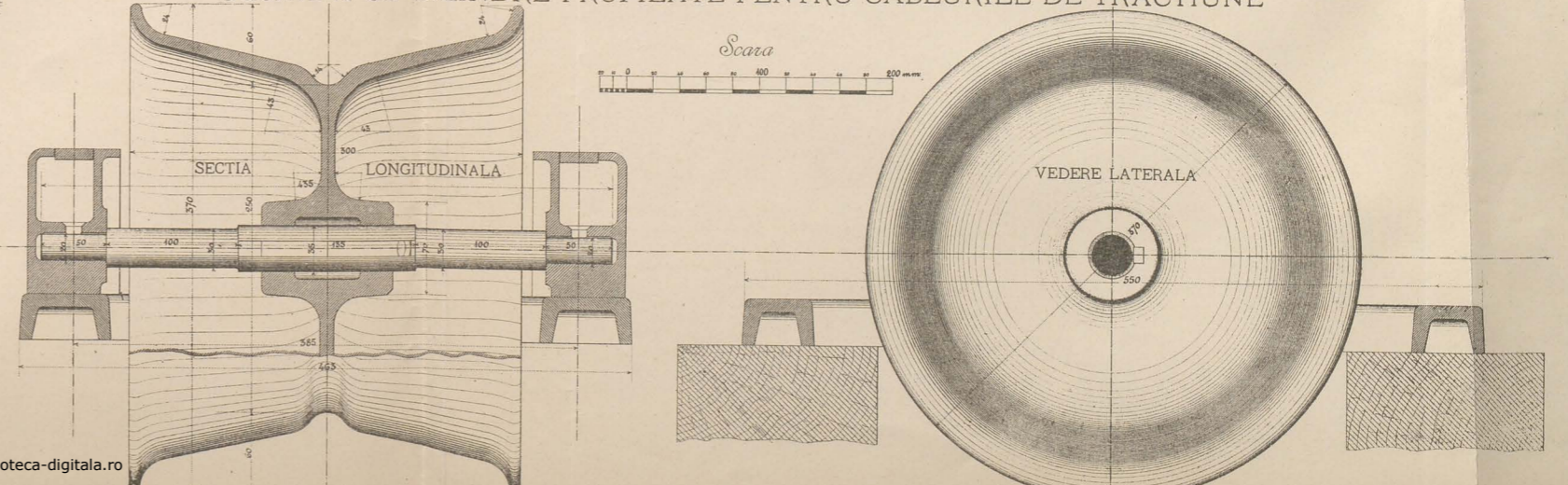

# CALEA TELEDINAMICA TIRGU OCNA-SALINE

## STATIUNEA DE DISCARCARE

PLAN

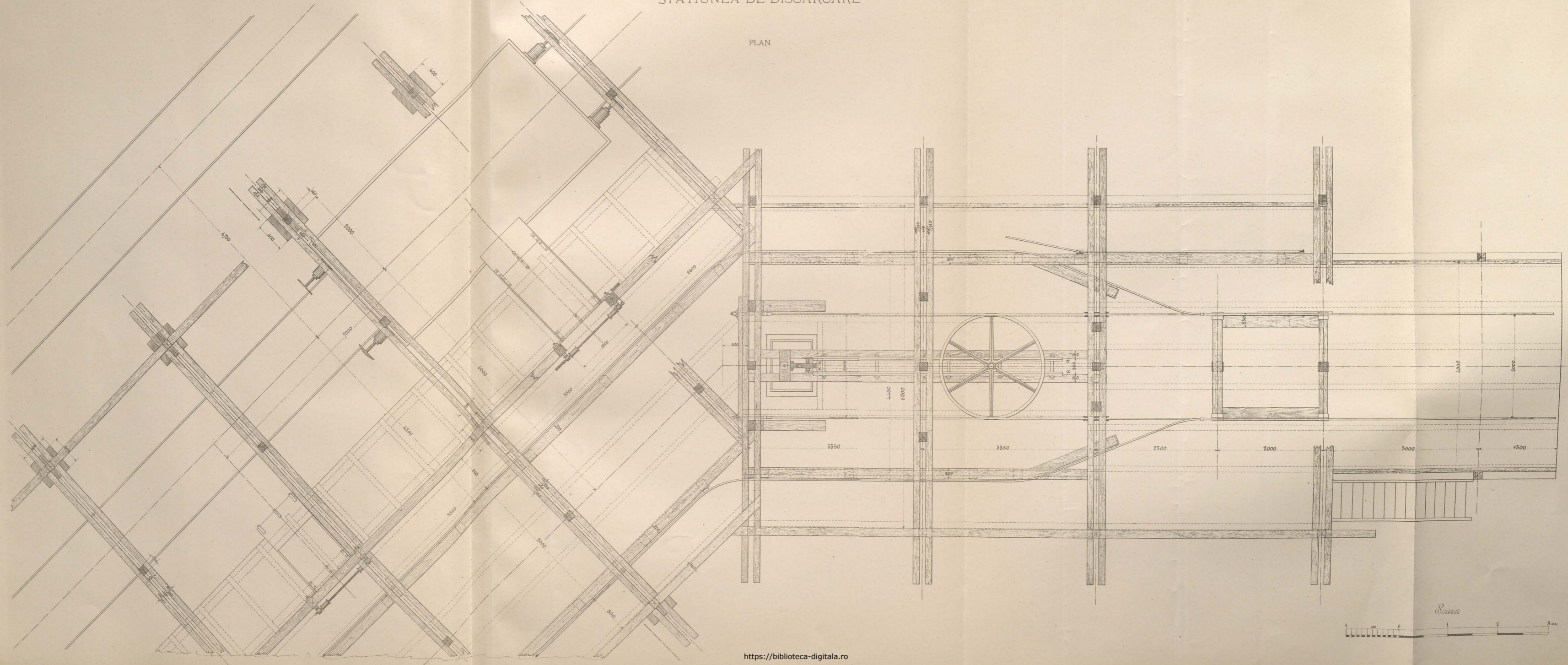

# CALEA TELEDINAMICA TIRGU OCNA-SALINE

969.

## STATIUNEA DE DISCARCARE

SECȚIA A

SECȚIA D

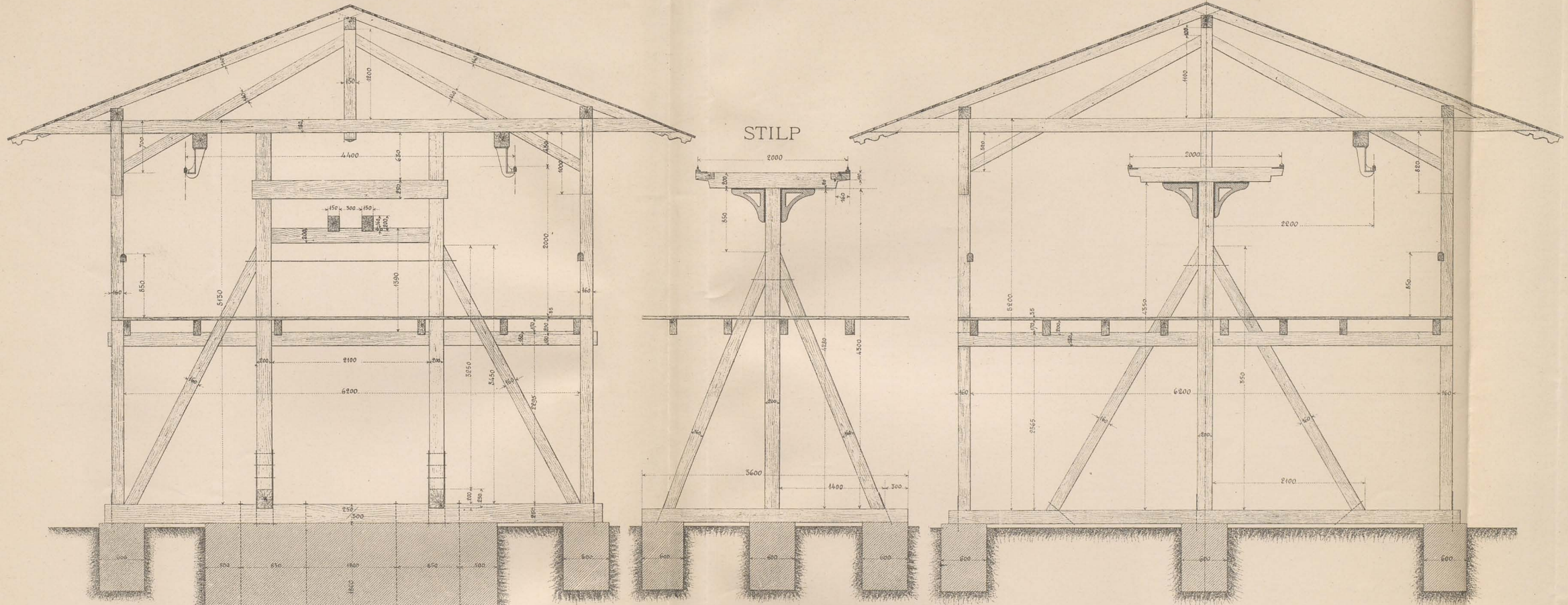

CUSINETI CU CILINDRU DE FER  
PENTRU CABLURILE DE TRACȚIUNE

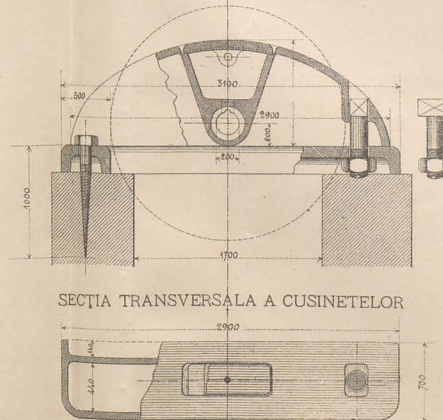
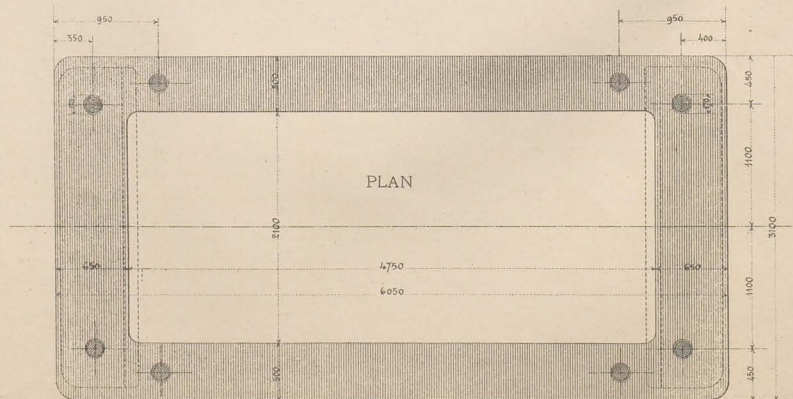

SECȚIA ÎN LUNG A CILINDRILOR

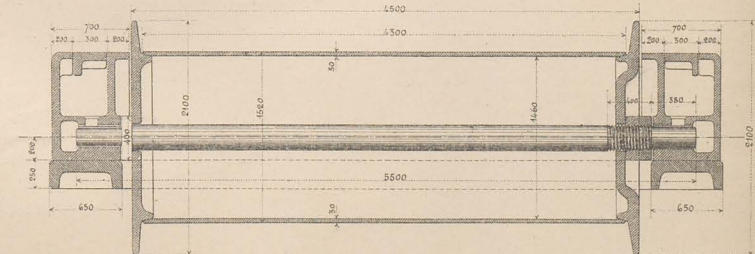

Scara pentru toate figurile

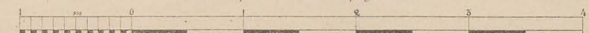

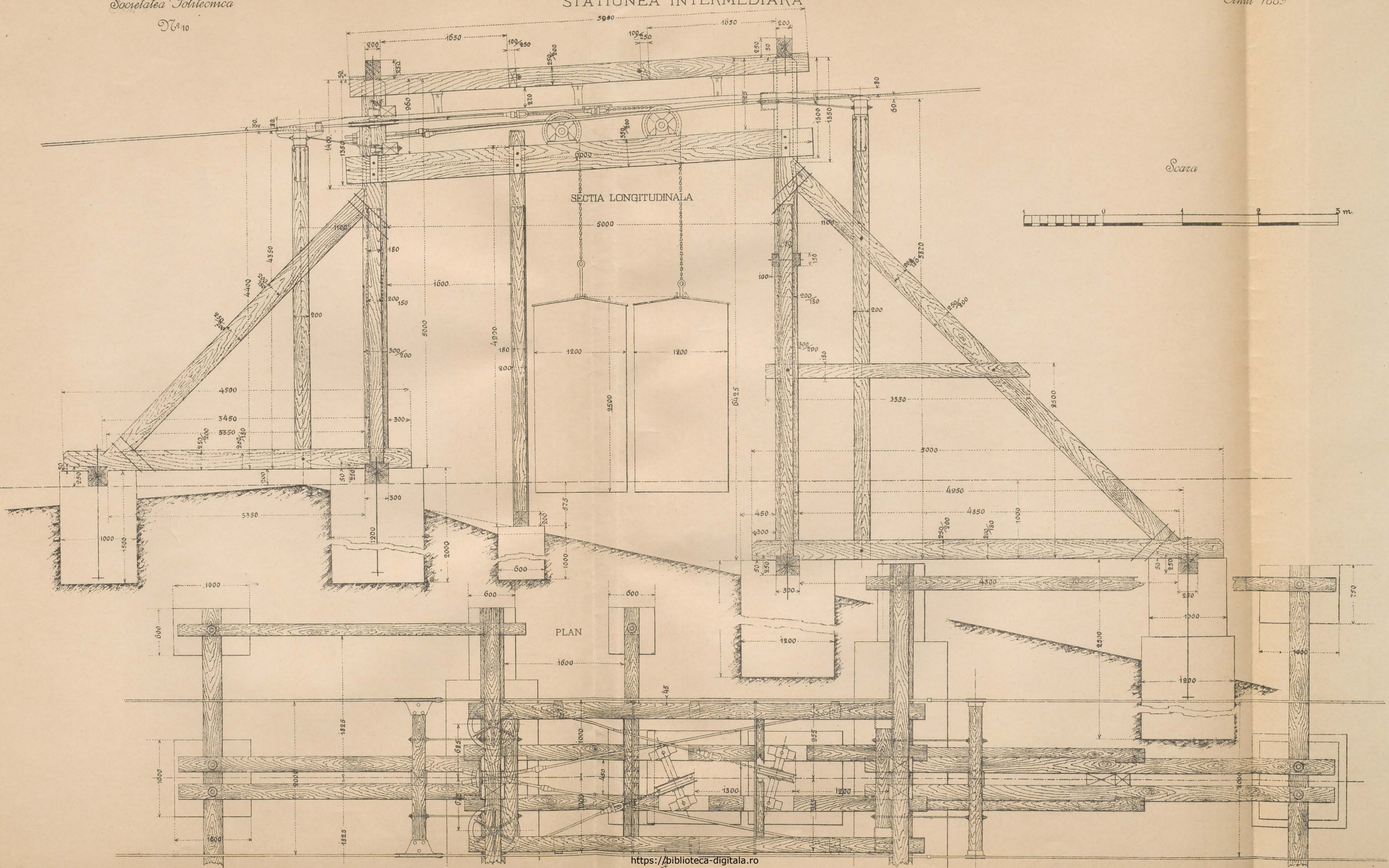

SECTIA LONGITUDINALA

PLAN

Scara

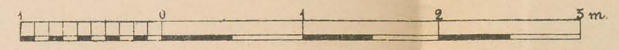

# CALEA TELEDINAMICA TIRGU OCNA-SALINE

## APARAT DE CUPLARE

ANSAMBLU

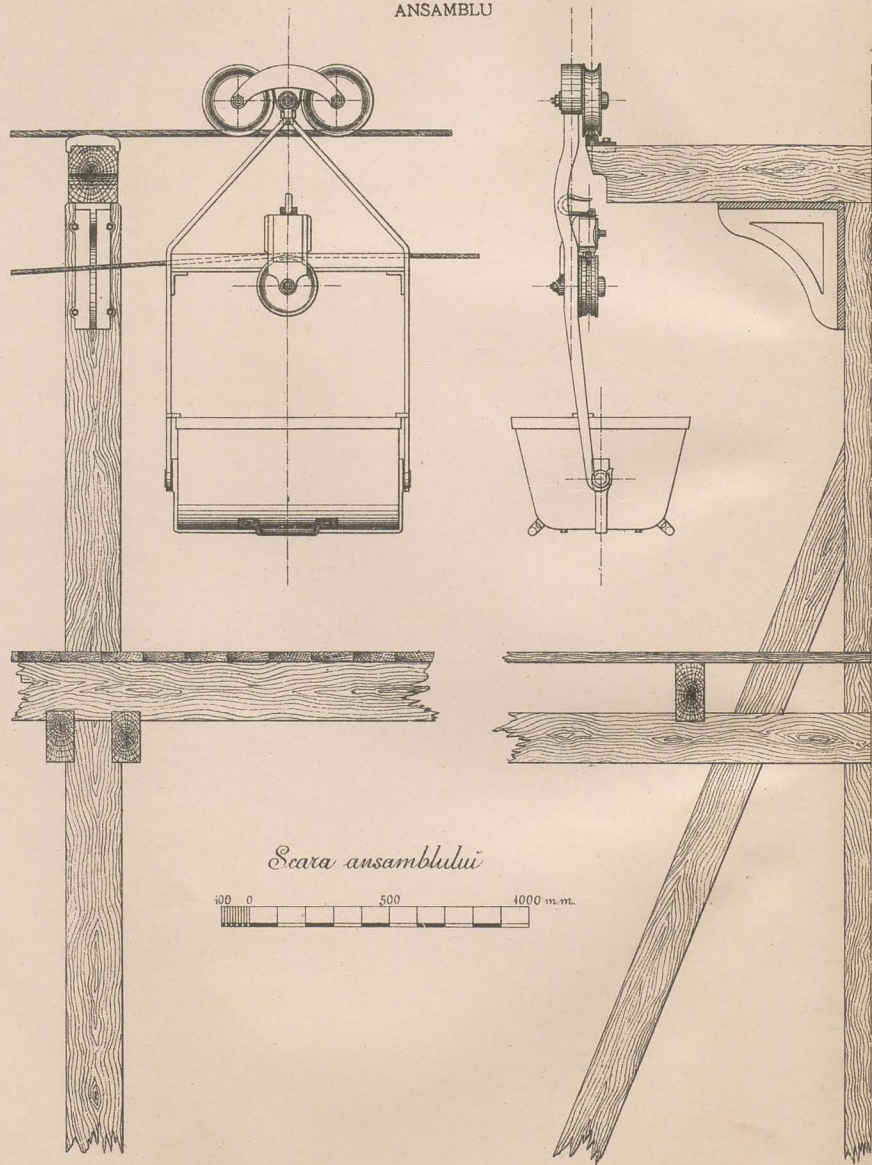

Scara ansamblului

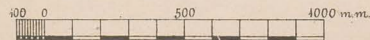

Scările detaliilor

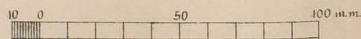
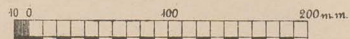

VEDERE DE DESUPT

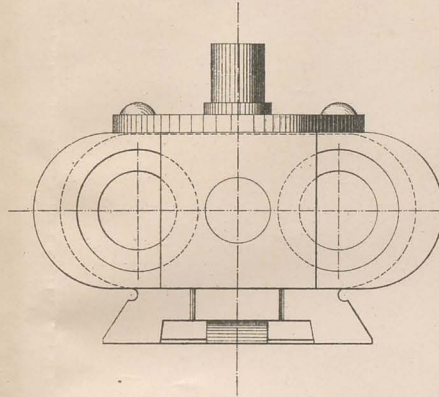

SECȚIE HORIZONTALĂ

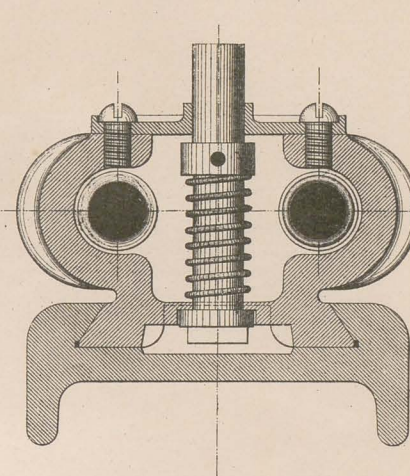

VEDERE DE DINAPOI

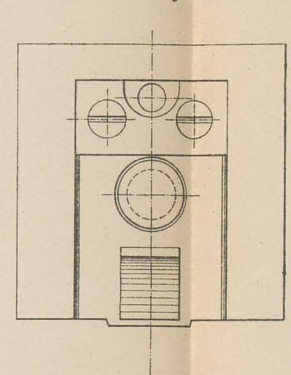

SECȚII VERTICALE

*În cursul calei*

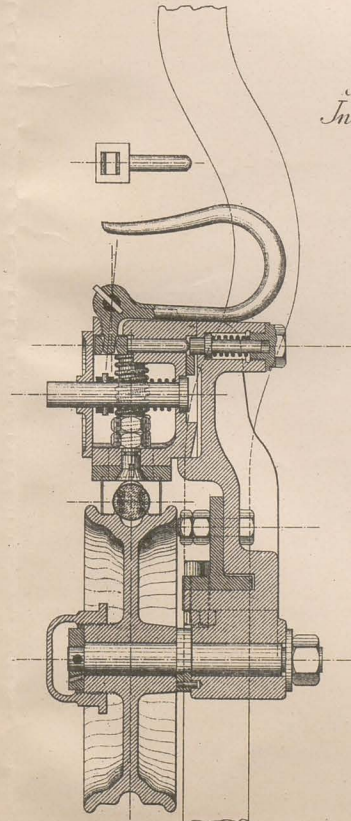

*Pe declanșor*

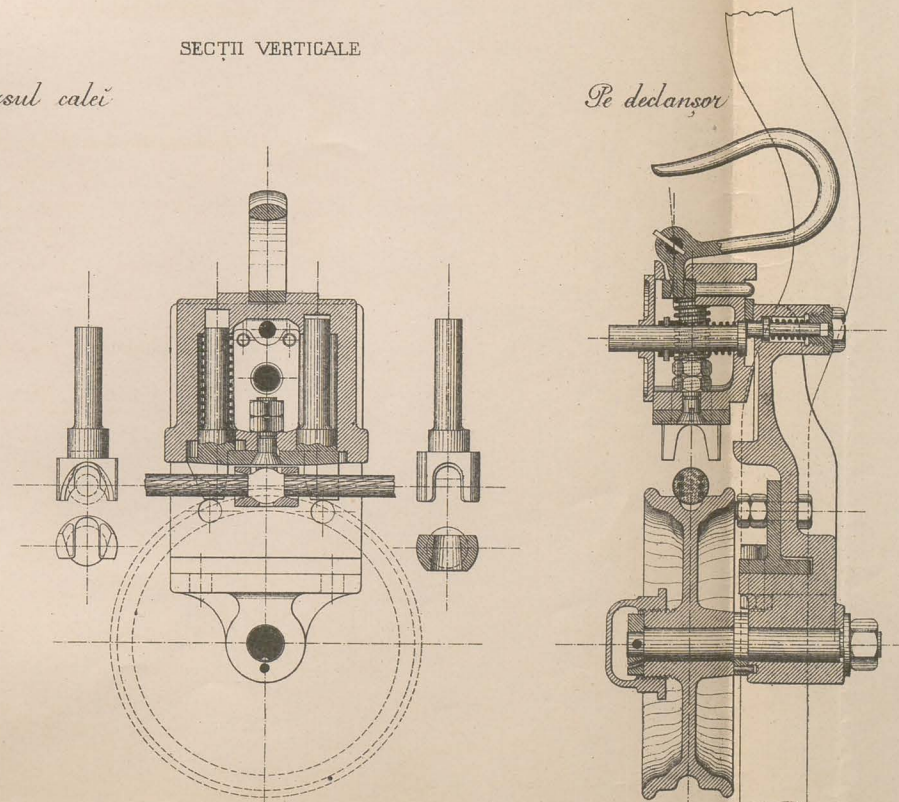

## DOCURILE DE LA BRAILA SI GALATZ

PROFIL TRANSVERSAL AL CHEULUI LA DUNARE

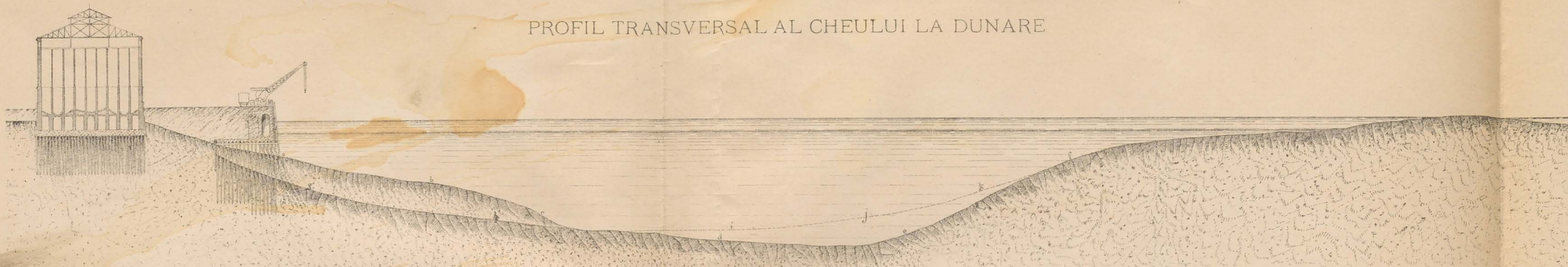

PROFIL TRANSVERSAL AL BASINULUI



## LEGENDA

- A. Magasi de grâne.
- B. Clădirea de mașini.
- C. Biroul.
- D. Intreosite de mărfuri.
- E. Clădirea administrației.
- F. Hangare pentru mărfurile de transit.
- G. Corpul de gardă. Portar. Post de pompieri.
- a. Macara plutitoare de 40 tone.
- b. Macara fixă de 40 tone.
- c. Macara mobilă de 1½ tone.
- d. Elevatori de 150 tone pe oră.
- e. Vasul cel mai mare sosit în portul Brăila.
- f. Vase de mărime medie.
- g. Vase mici.

PLANUL BASINULUI LA BRAILA

Clădirile hașurate sunt cele ce se construiesc acum

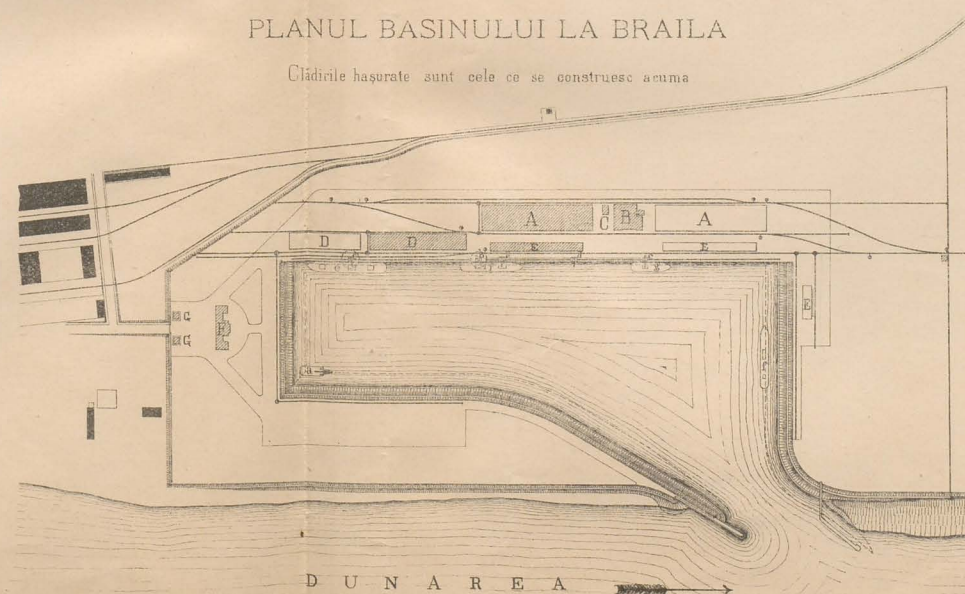

Scara Profilelor

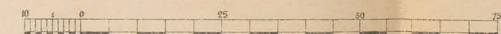

Scara Planului

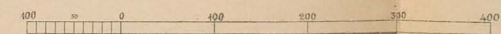



# TABLOUL

## VAGOANELOR ACOPERITE (SERIA G SI G') EXPEDIAȚIE ÎNCARCATE SI GOALE

IN TRIMESTRUL I, II, III ȘI IV 1888

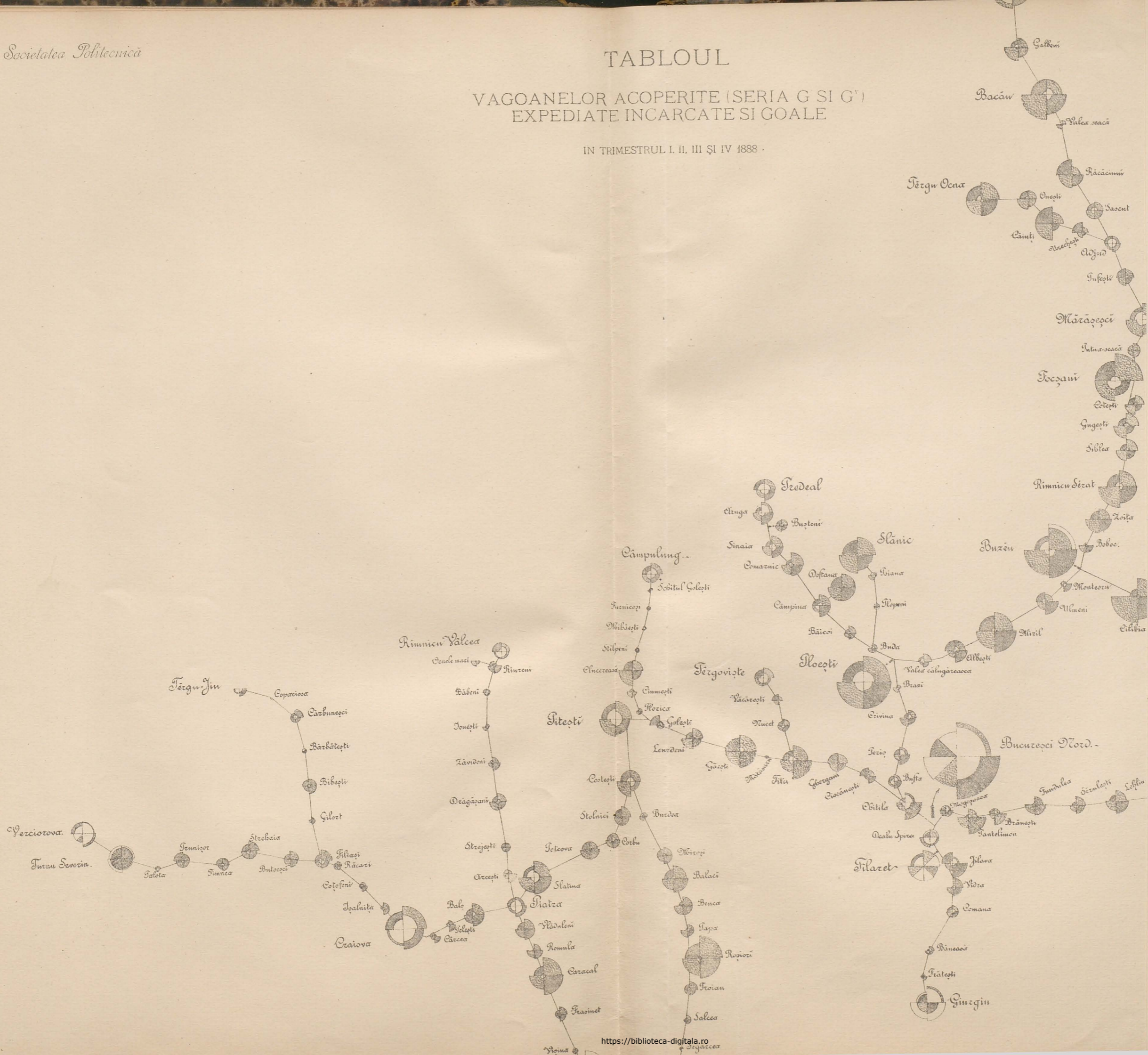

REGISTRUL A. A. J. R. C. R.  
Biblioteca Centrală  
No. \_\_\_\_\_

# TABLOUL

## VAGOANELOR ACOPERITE (SERIA G SI G') EXPEDIAȚIE ÎNCARCATE SI GOALE

IN TRIMESTRUL I, II, III ȘI IV 1888



### Legenda

- Vagone încărcate
  - Vagone goale
- 10 = pătrăți = 25 vagoane calculat  
le pe suprafața totală a cercului  
în întreg.

Fie care trimestru este exprimat printr-un număr de cercuri în ordinea nr. mășinii

MACARA PLUTITÓRE  
DE 40 TONE



SECTIA TRANSVERSALA

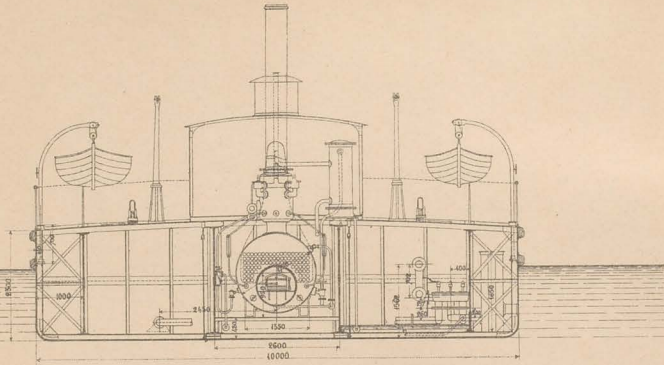

SECTIA TRANSVERSALA

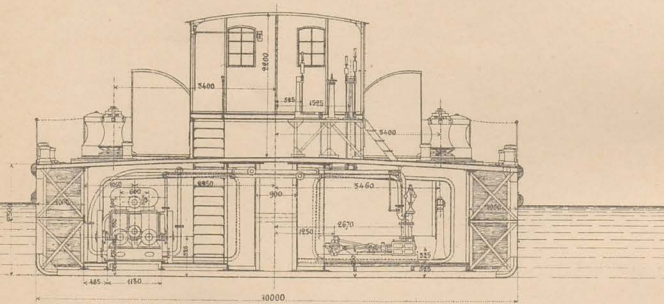

SECTIA LONGITUDINALA

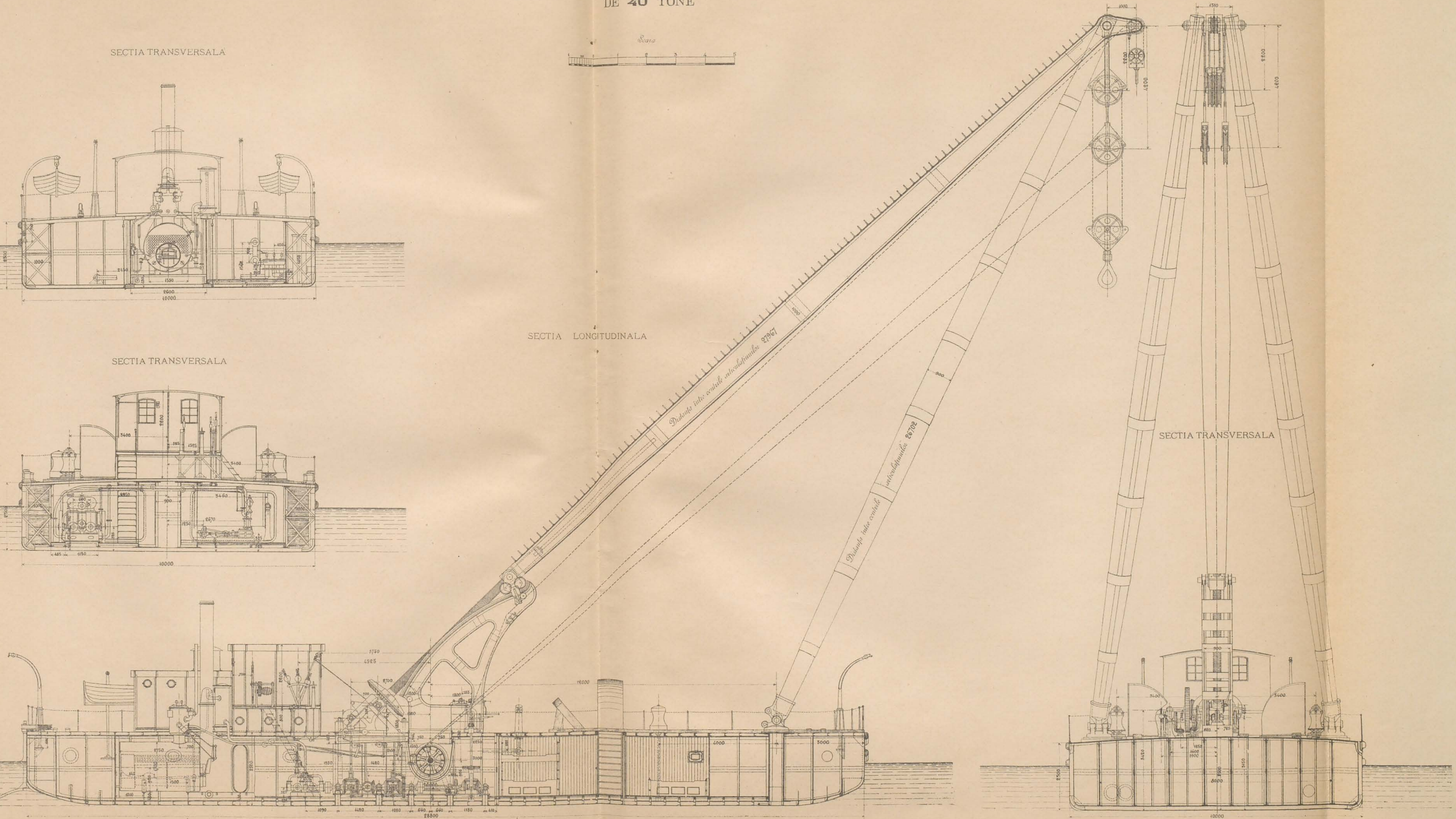

SECTIA TRANSVERSALA

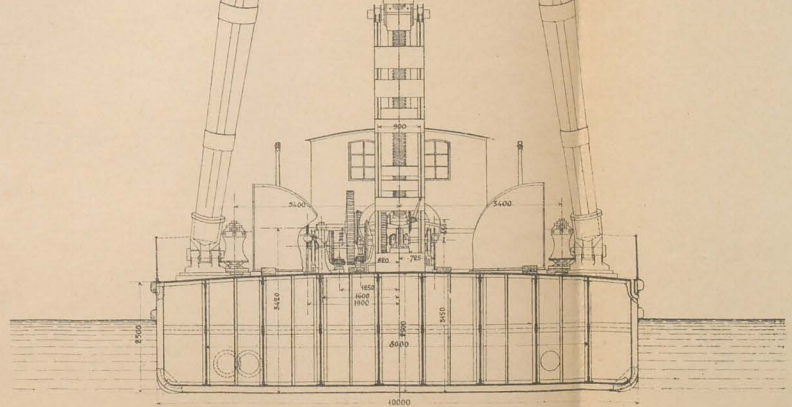

SECȚIE HORIZONTALĂ

MACARA PLUTITORE

DE 40 TONE

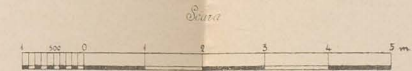
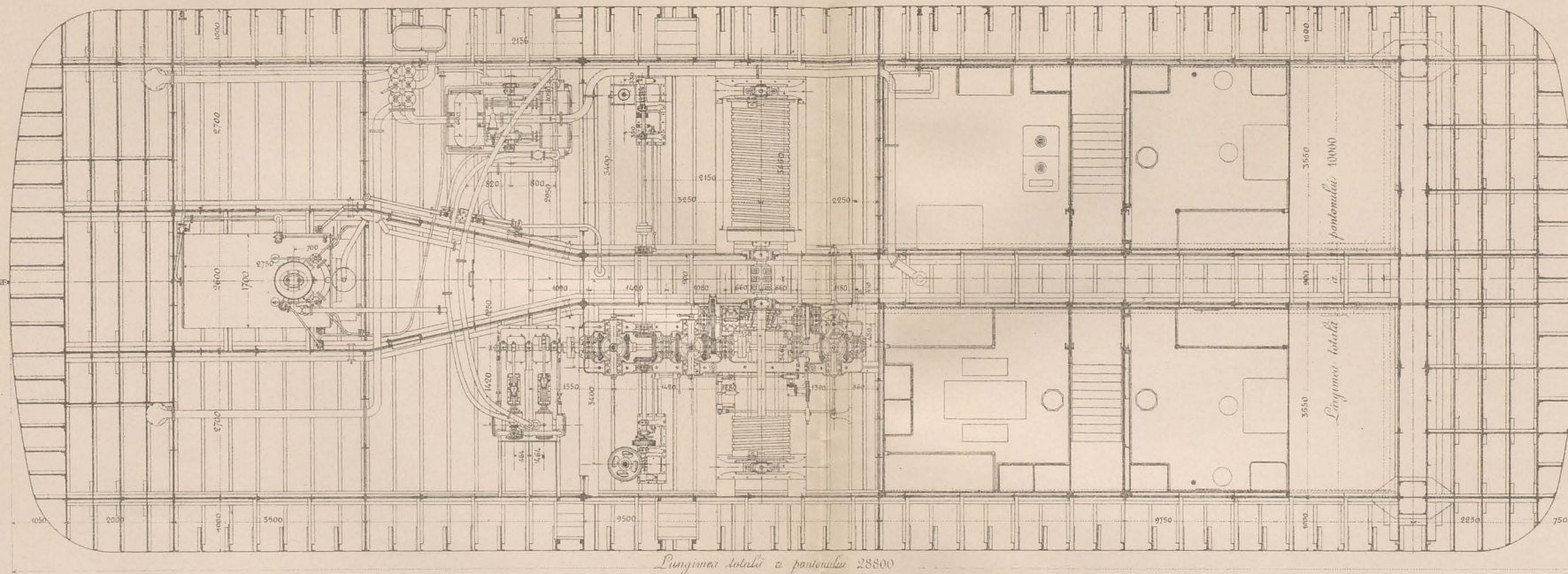

PLAN

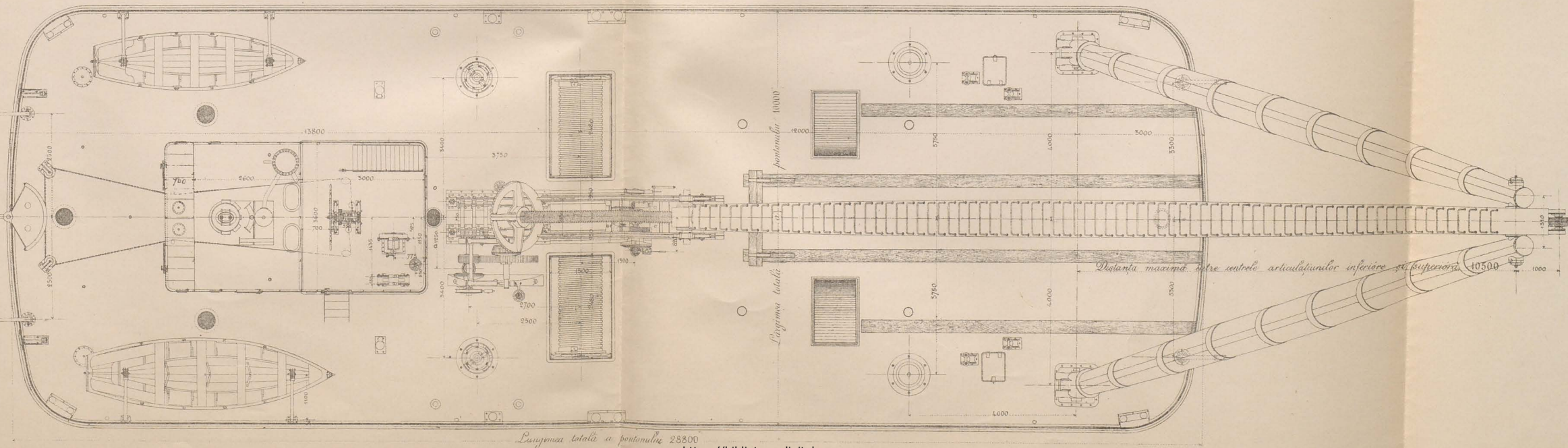

# CALEA FERATA BUCURESTI-FETESTI

## TUNELUL DIN VALEA MOSTISTEA

ELEVATIA CAPETULUI SPRE VALE

PLAN DE SITUATIE

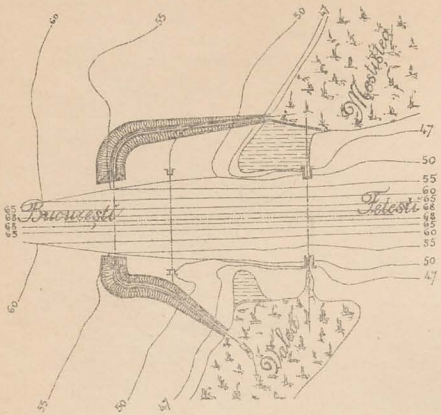

SECTIE LONGITUDINALA

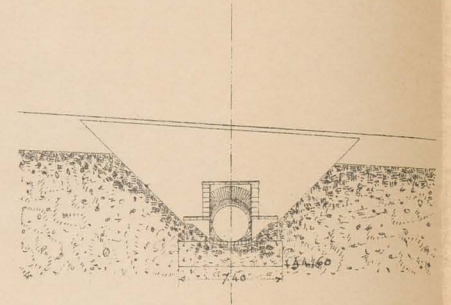
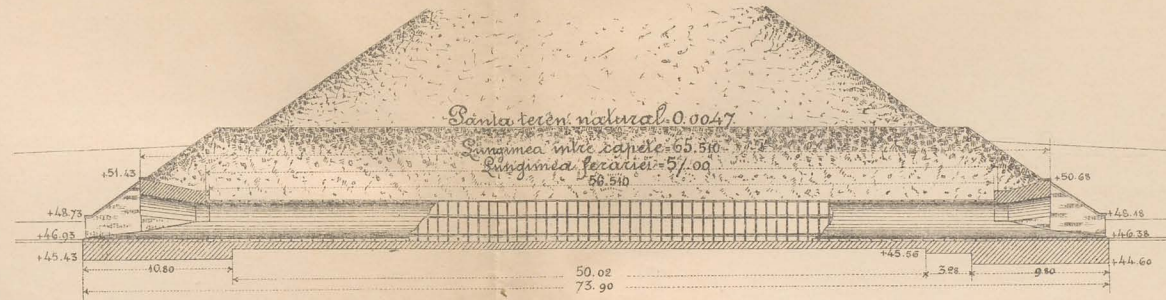

SECTIA A B

SECTIA C D



PLAN

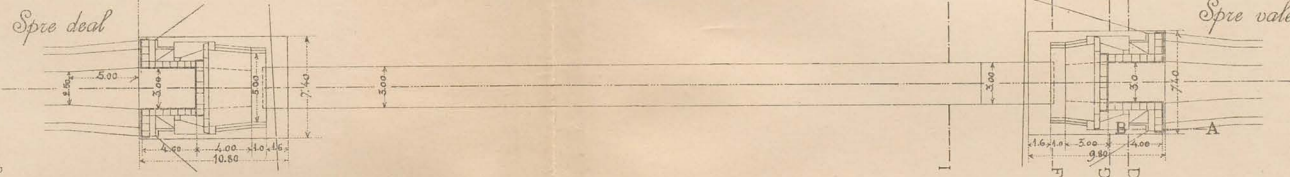

SECTIA G H

SECTIA I K

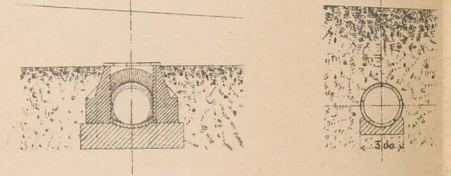

DETALIURILE TUNELULUI

SECTIA E F

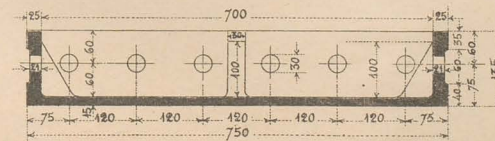
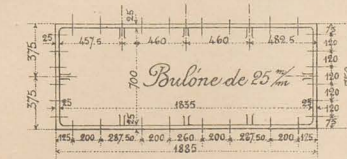
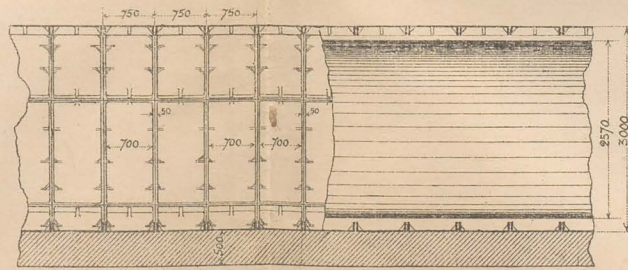
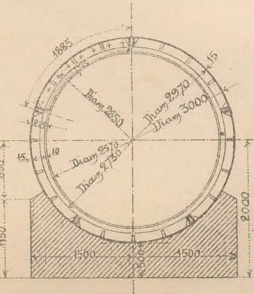
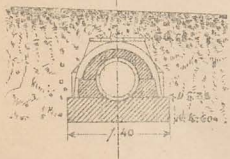

SECTIA CANALURILOR

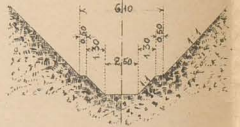

Scara Planului de situatie

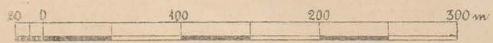

Scara desenerilor

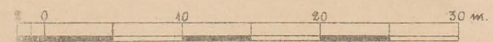

Scările detaliilor

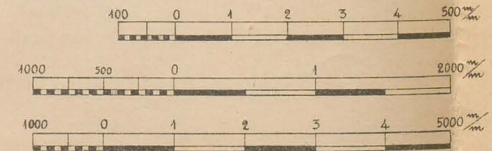

INCERCARI LA TRACTIUNE A TOELOR DE FER SI OTEL  
CURBE REPRESENTAND VARIATIUNI IN RESISTENTA SI LUNGIRE

Fig. 1.

TIP DE INCERCAT

Lungimea între reperele A B = 200 mm

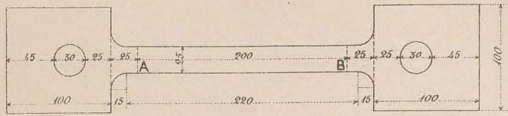

Fig. 5.

TOLA DE FER N. 5 — FORGEA X

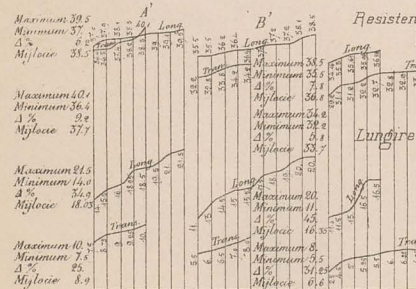

Fig. 2. TOLA DE FER N. 3. — FORGEA X

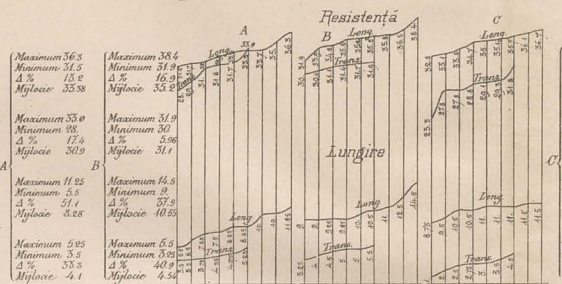

Fig. 3. TOLA DE FER N. 3. — FORGEA X

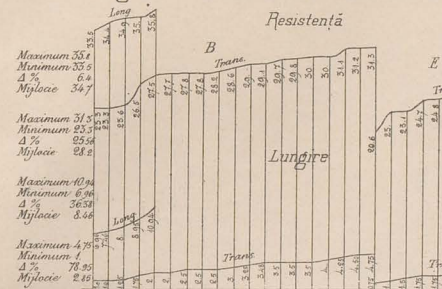

Fig. 4. TOLA DE FER N. 3. — FORGEA X

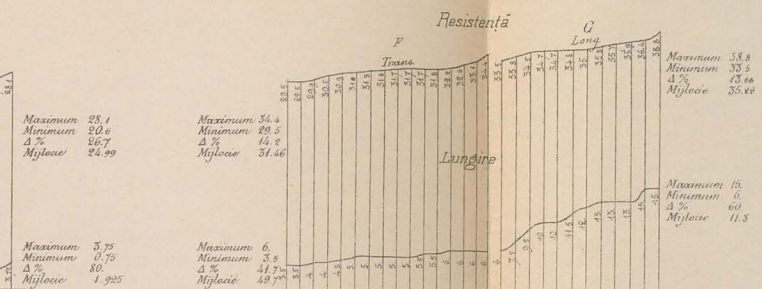

Fig. 6. TOLA DE FER N. 5 — FORGEA X

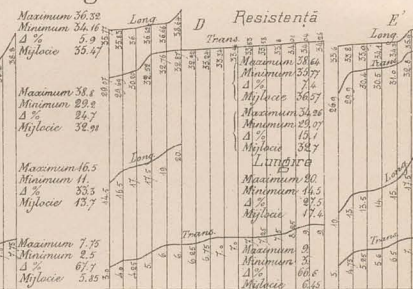

Fig. 7. TOLA DE FER N. 6 — FORGEA Y

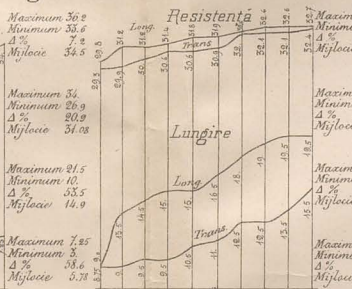

Fig. 8. TOLA DE FER N. 6 — FORGEA Y

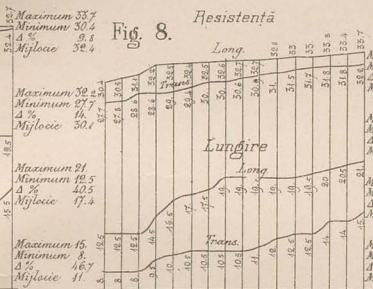

Fig. 9. TOLA DE FER N. 7 — FORGEA Y

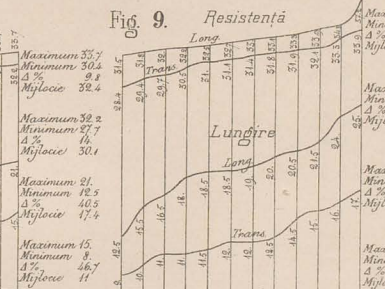

Fig. 10. TOLA DE OTEL DE DENAIN

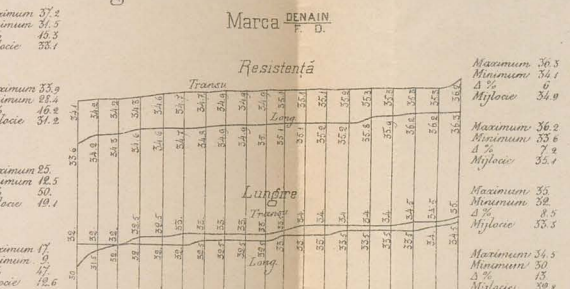

Fig. 11. TOLA DE OTEL DE DENAIN

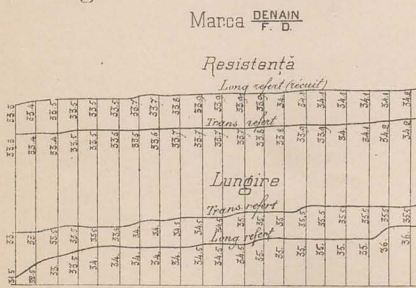

Fig. 12. TOLA DE OTEL DE DENAIN

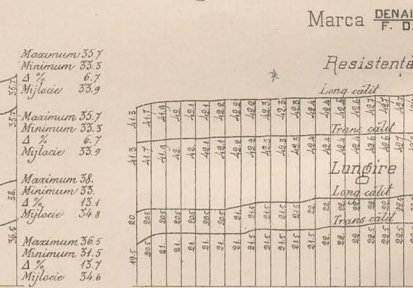

Fig. 13. TOLE DE OTEL DE 7 SI 8% GROSIME

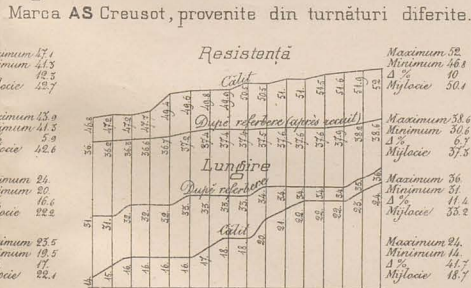

Fig. 14. TOLE DE OTEL Marca AS Creusot,

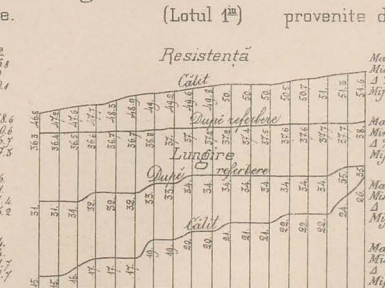

Fig. 15. TOLE DE OTEL

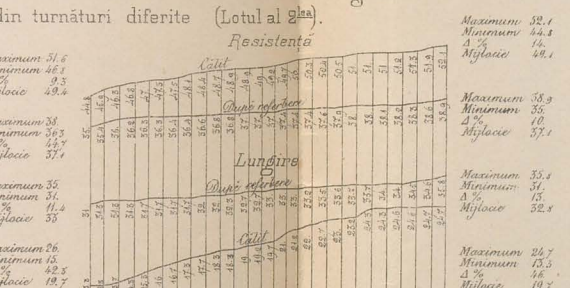

Fig. 16. DIFERITE TOLE DE 8% GROSIME, Marca AS Creusot, provenite din aceeași turnătură (coulée)

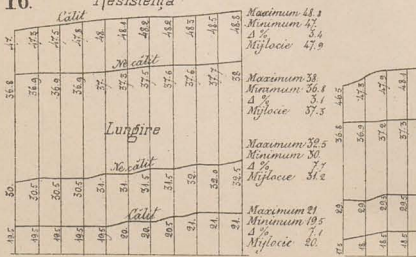

Fig. 17. TOLE DE OTEL DE 7% GROSIME, Marca AS Creusot, provenite din turnături diferite

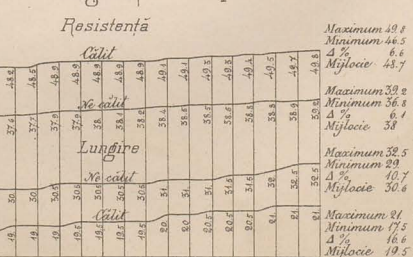

Fig. 18. TOLE DE OTEL DE 8% GROSIME, Marca AS Creusot



Fig. 19. TOLA DE OTEL DE 18% GROSIME, Marca AS Creusot

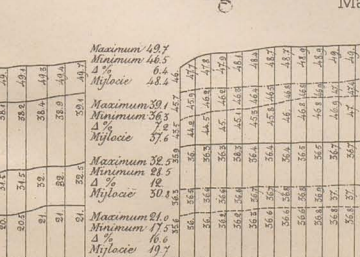
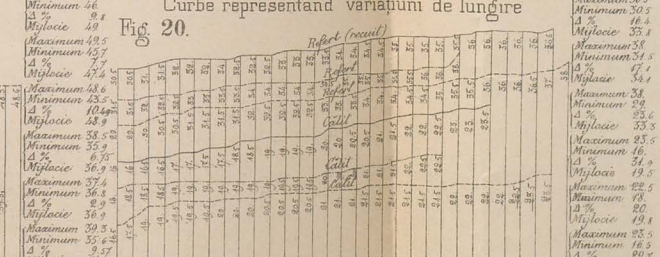

Fig. 20. Curbe reprezentând variațiuni de lungire



Nº 2

# ATHENEUL ROMAN

SECTIA CUPOLEI.

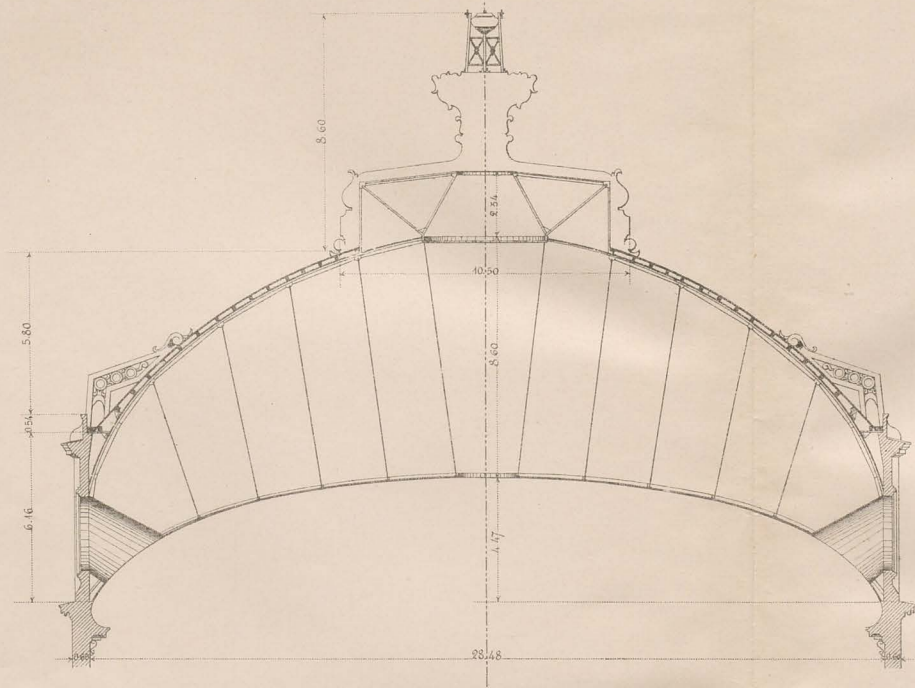

PLANUL GENERAL

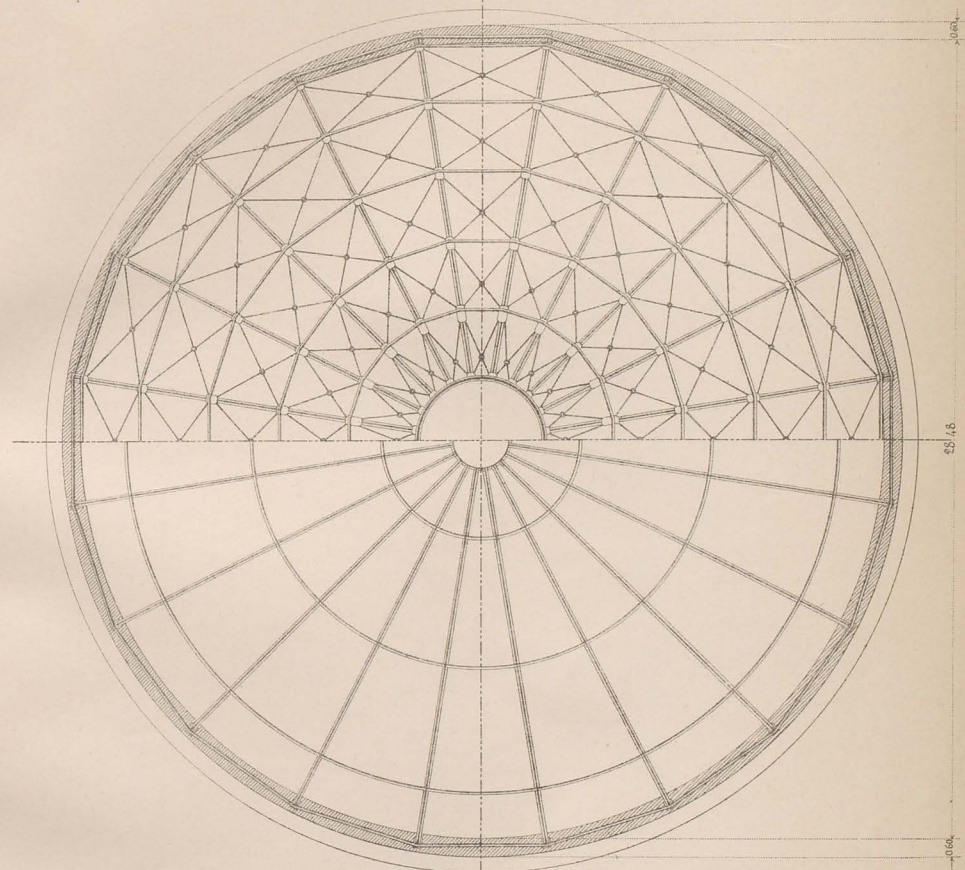

DETALIUL FERESTRELOR.

*Sectie.*

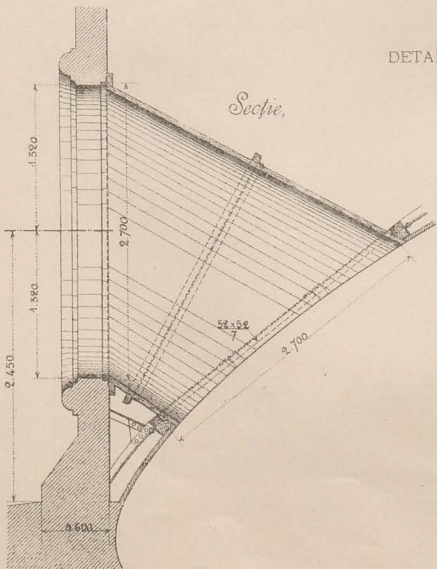

*Elevatie.*

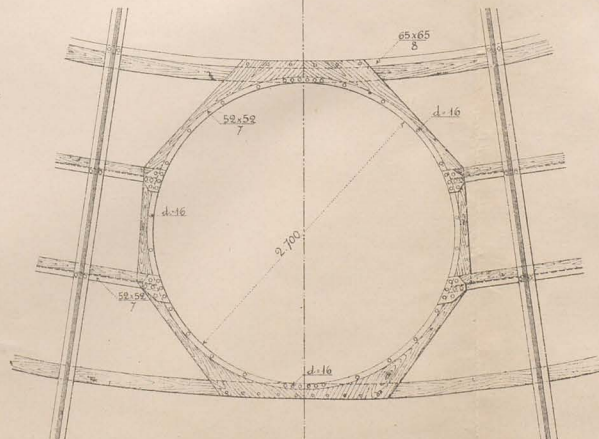

*Scara Planului general si a Sectiunii cupolei.*



*Scara detaliilor.*

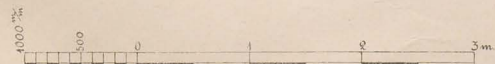

DETALIUL INELULUI VII PE ZID

*Elevatie.*

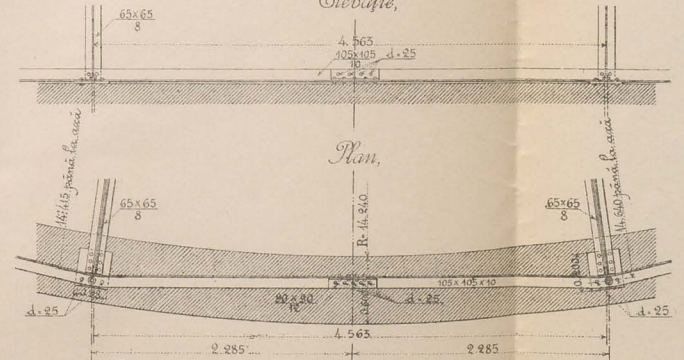

*Plan.*

# ATHENEUL ROMAN

## SECȚIA TRANSVERSALA A CUPOLEI

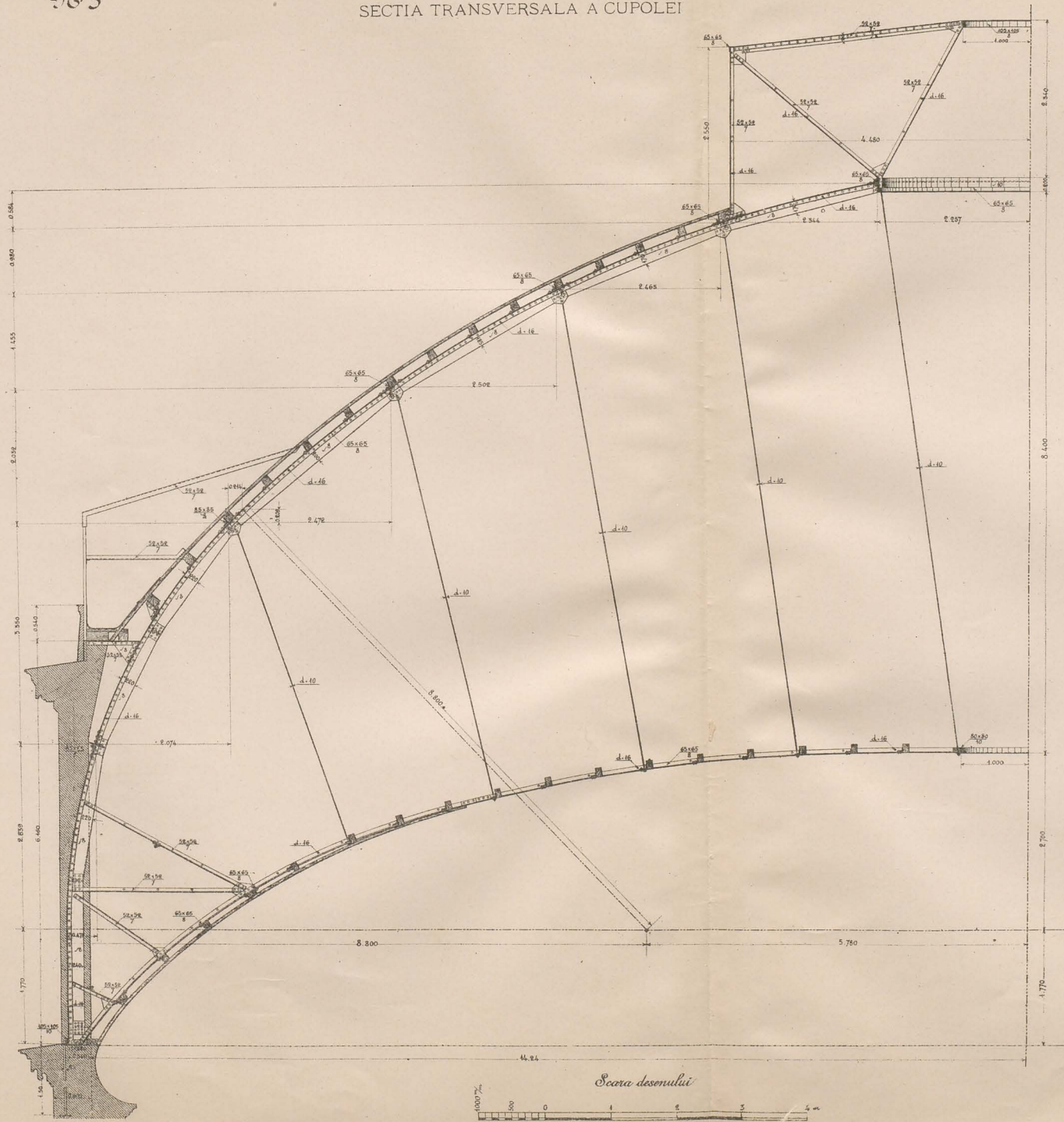

## PLANUL FERMEI (DEVELOPATE)

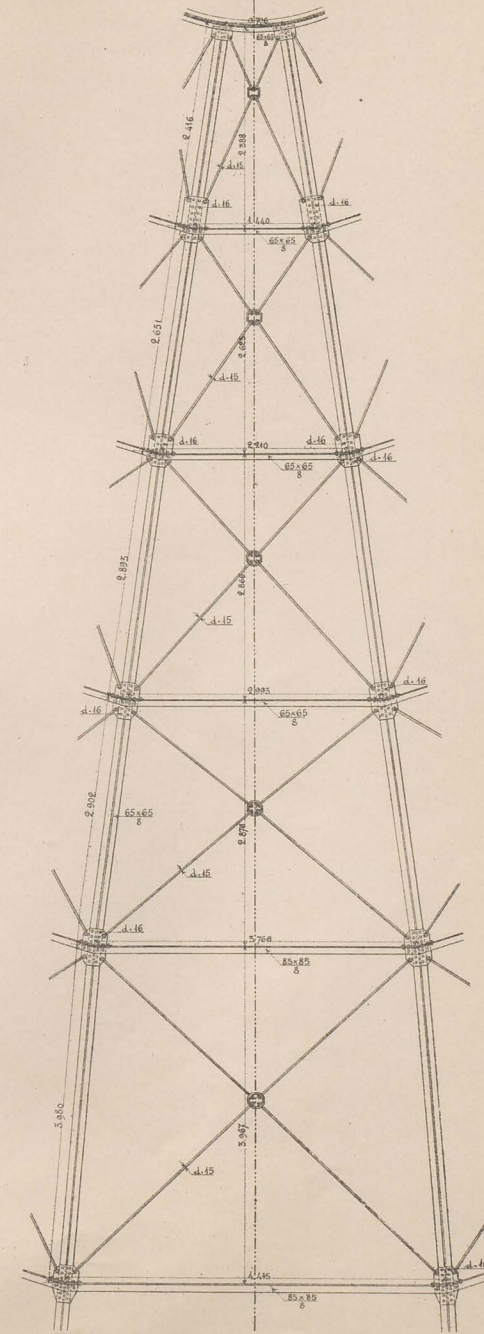

### SECȚIUNILE FERMEI

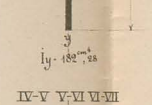
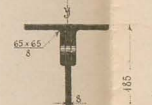
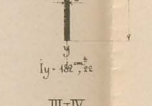

### SECȚIUNILE INELOR

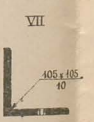

### SECȚIA DIAGONALELOR





# TURNUL DE 300 METRI

## DIAGRAMA

ELEVAȚIE

Fig. 3

Etajul al 5<sup>lea</sup>

Nivelul planșeului (554,815)

Nivelul planșeului (502,65)

SECȚIE HORIZONTALĂ — PARTEA INFERIOARA

Fig. 1

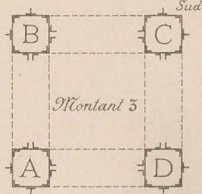
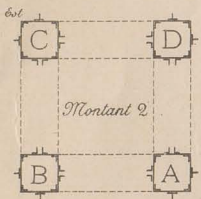

SECȚIE HORIZONTALĂ — PARTEA SUPERIOARA

Fig. 2

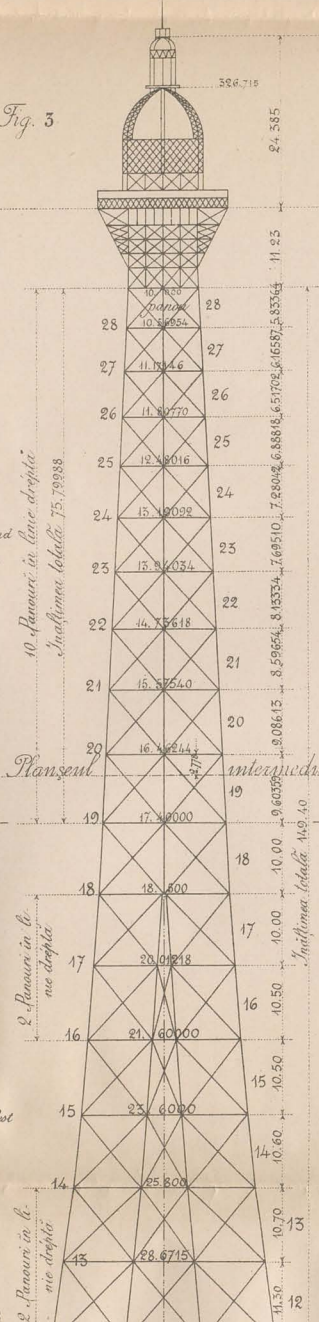
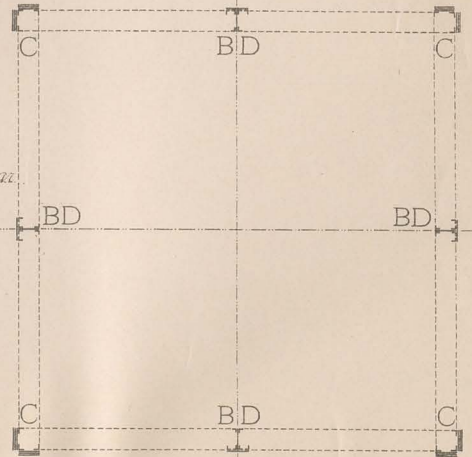

Nota.  
Toate cotele de lărgime sunt cele exterioare

Etajul al 2<sup>lea</sup>

Nivelul planșeului (149,25)

Etajul al 1<sup>lea</sup>

Nivelul planșeului (91,15)

Nivelul la planșeul etajului al 2<sup>lea</sup> - 115,25

Nivelul la planșeul etajului al 1<sup>lea</sup> - 115,00

Nivelul la planșeul etajului al 1<sup>lea</sup> - 55,13

Solu (34,015)

Nivelul cotelor suporturilor de pământ (56,00)

Înălțimea 275,65

300,00

N. N° 1.

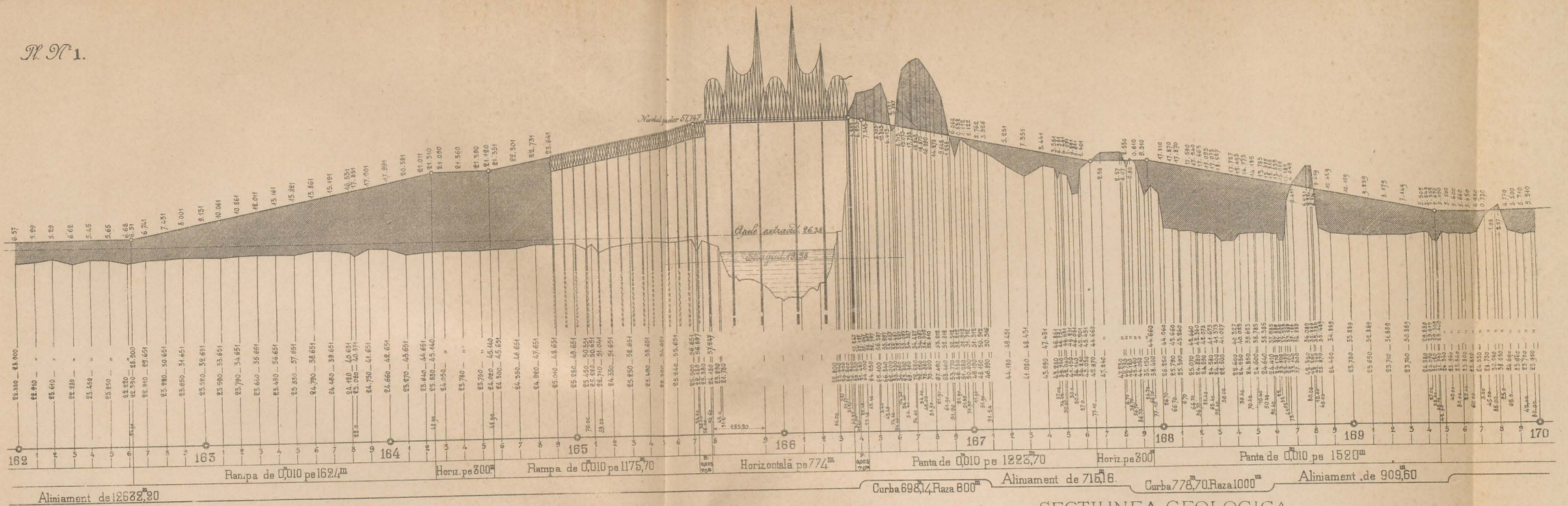

PLAN DE SITUATIE

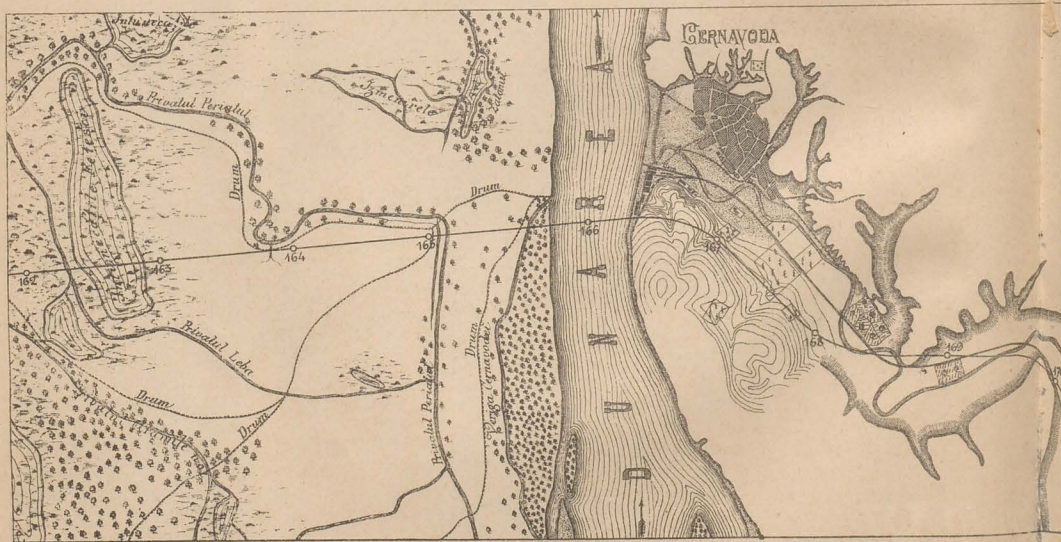

Scara Planului de situatie

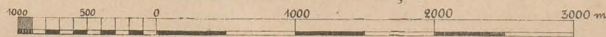

Scările Profilului longitudinal Pentru lungimi

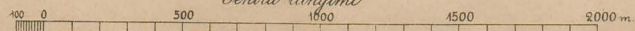

Pentru înălțimi

Scările Secțiunii geologica Pentru lungimi

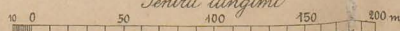

Pentru înălțimi

SECȚIUNEA GEOLOGICA

IN AMONTE DE CERNAVODA

Terțul stâng

Terțul drept

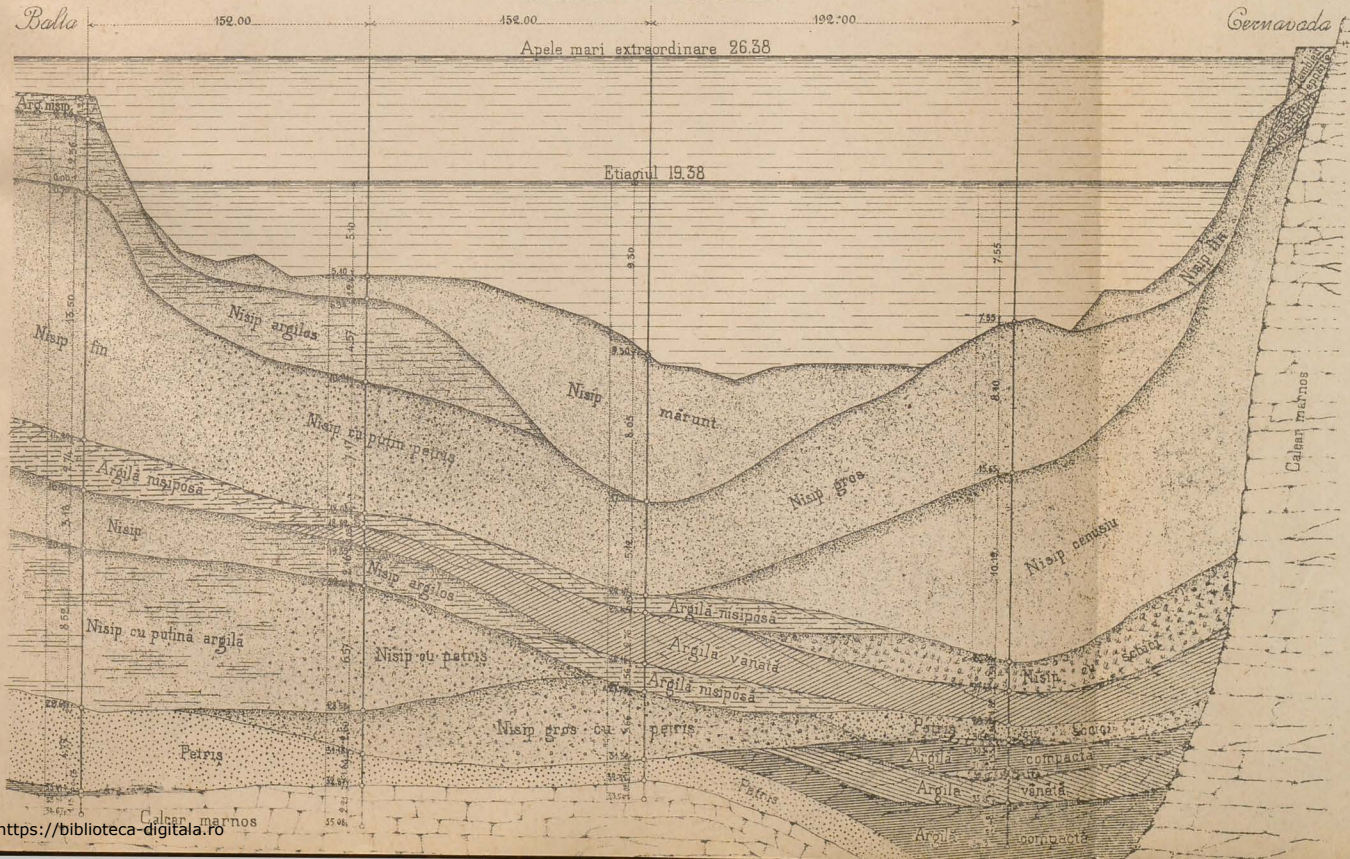

N. N. 2

# POD PESTE DUNARE LA CERNAVODA

## ELEVATIE



## PLAN

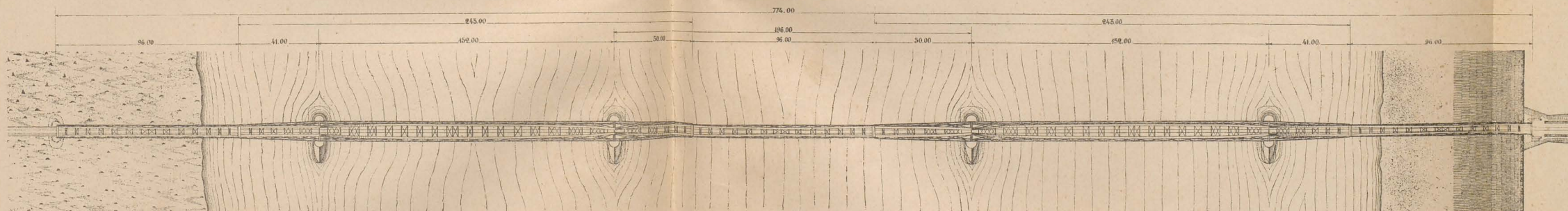

Sara

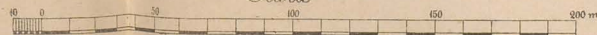

POD PESTE DUNARE LA CERNAVODA

DETALII DE IMBINARI

N. N. 3

NODURILE N° 30

NODURILE N° 1

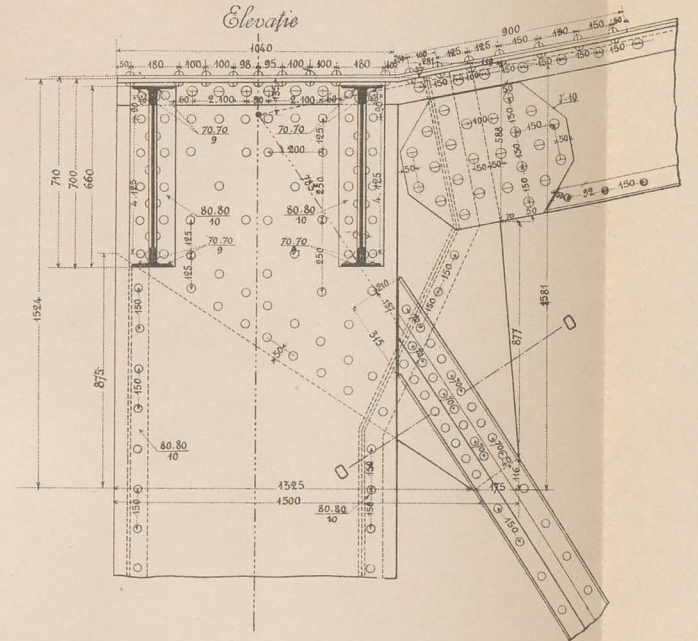
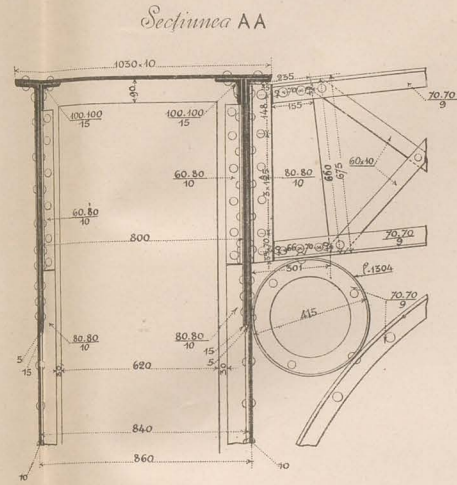
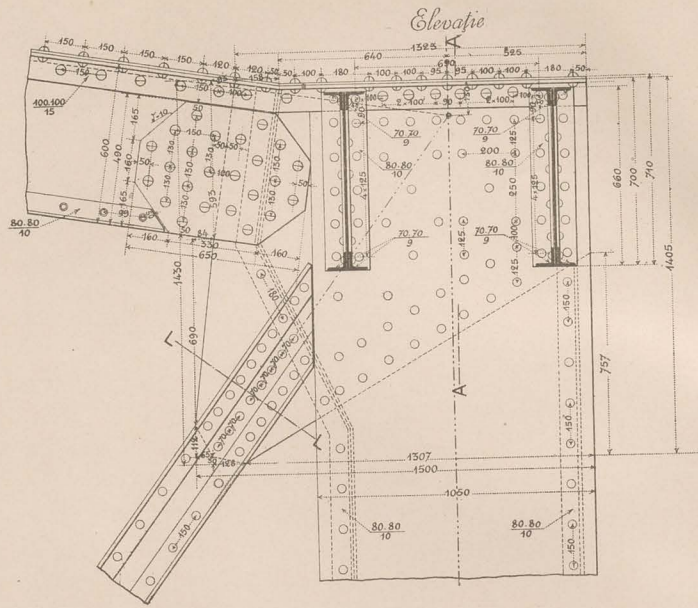

Secțiunea LL Secțiunea MM Secțiunea NN Secțiunea OO

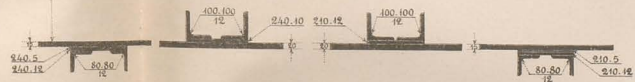
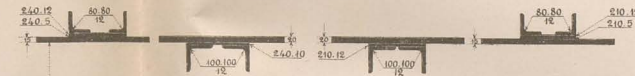

Secțiunea CC Secțiunea DD

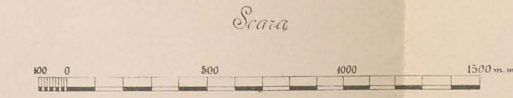
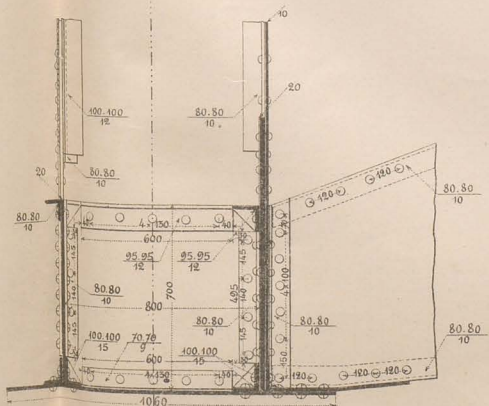
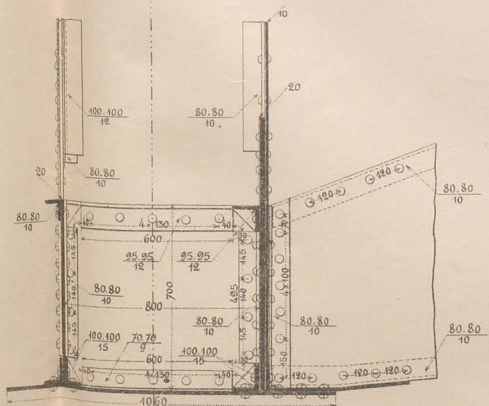

Legenda

- = Nituri de 18<sup>m</sup>
- = Nituri de 20<sup>m</sup>
- ⊕ = Nituri de 25<sup>m</sup>

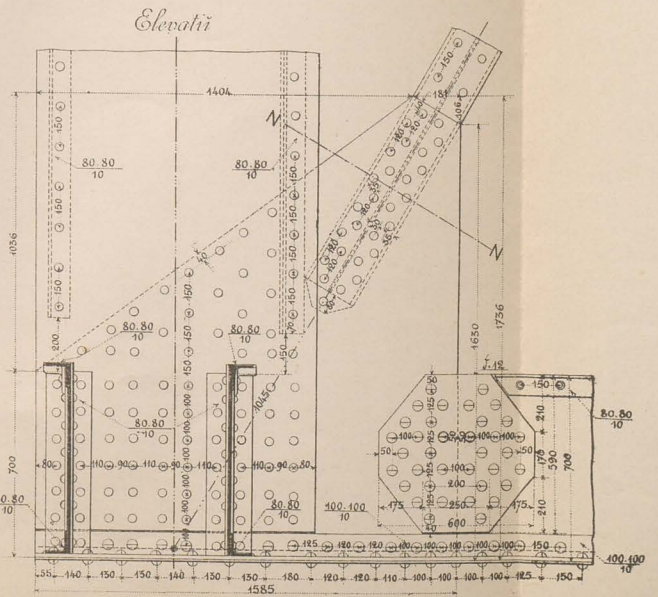
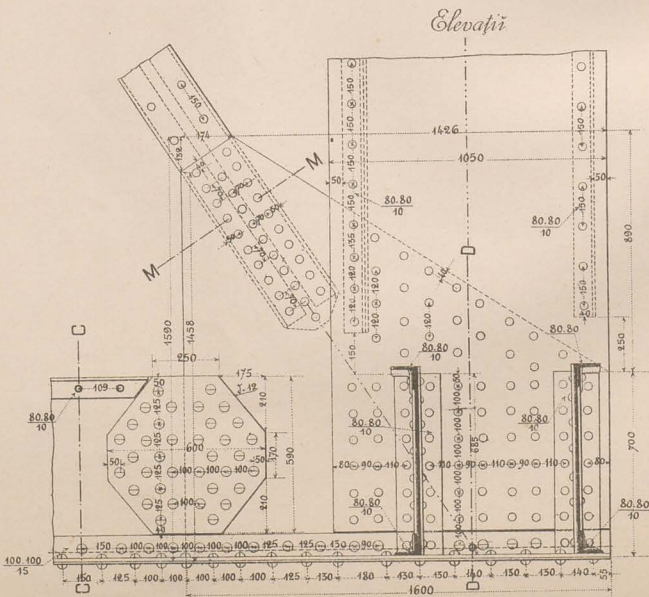

# POD PESTE DUNARE LA CERNAVODA

N. N<sup>o</sup> 4

NODUL N<sup>o</sup> 2

DETALII DE IMBINARI

NODUL N<sup>o</sup> 3

Elevație

Secțiunea BB      Secțiunea AA

Secțiunea II      Secțiunea KK

Elevație

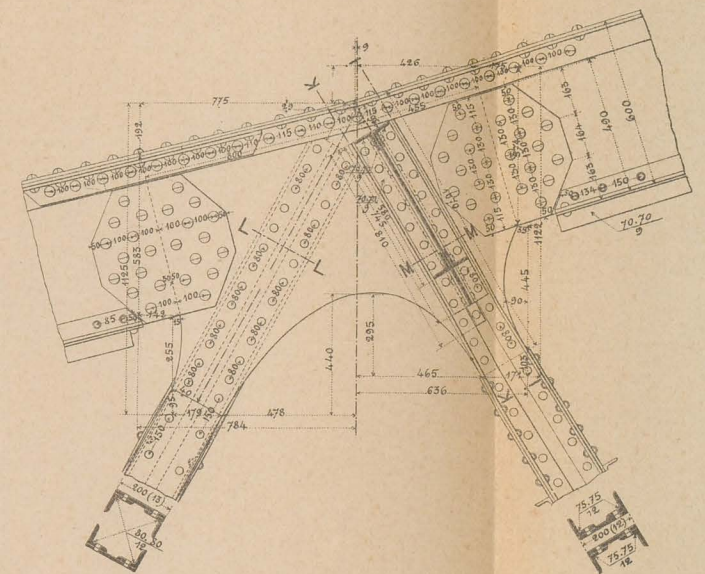
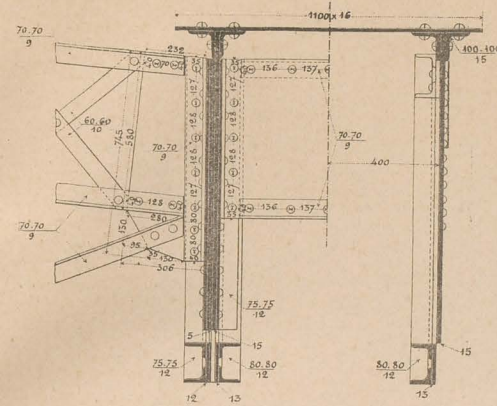
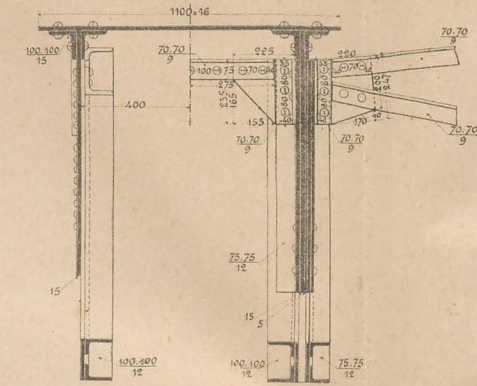
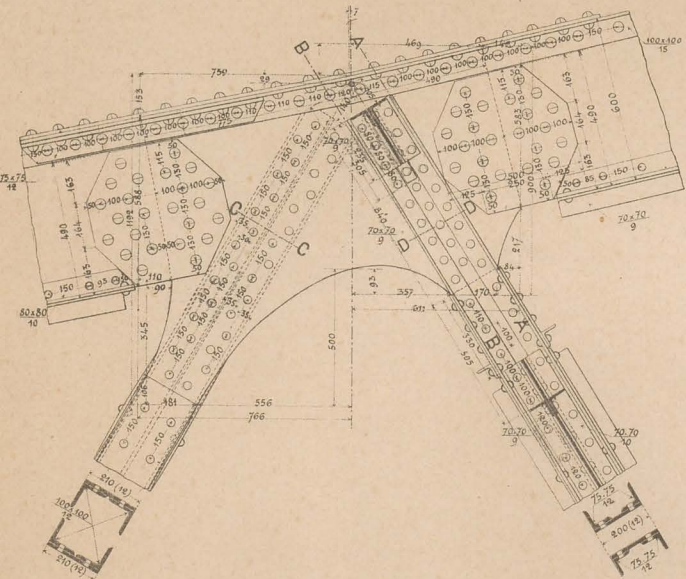

Secțiunea DD      Secțiunea CC

Secțiunea LL      Secțiunea MM

Scara

Legenda

- a Nituri de 18%
- b Nituri de 20%
- c Nituri de 25%

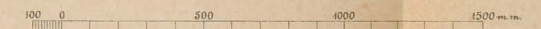
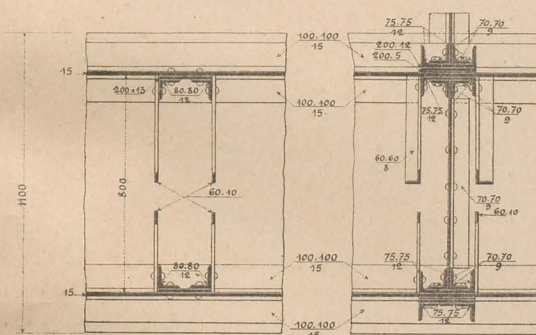
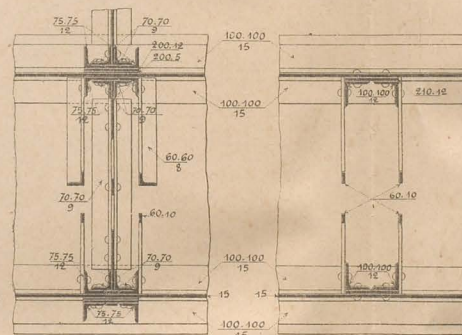

Elevație

Secțiunea FF      Secțiunea EE

Secțiunea NN      Secțiunea OO

Elevație

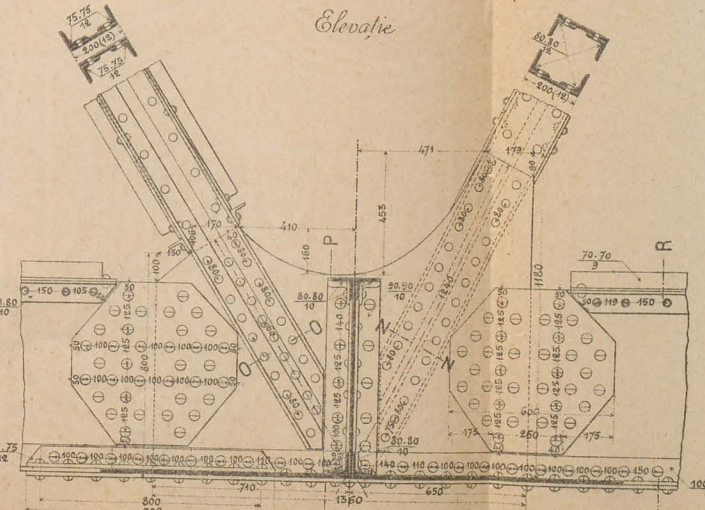
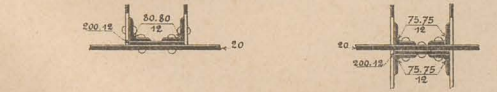
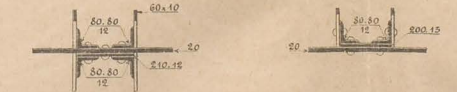
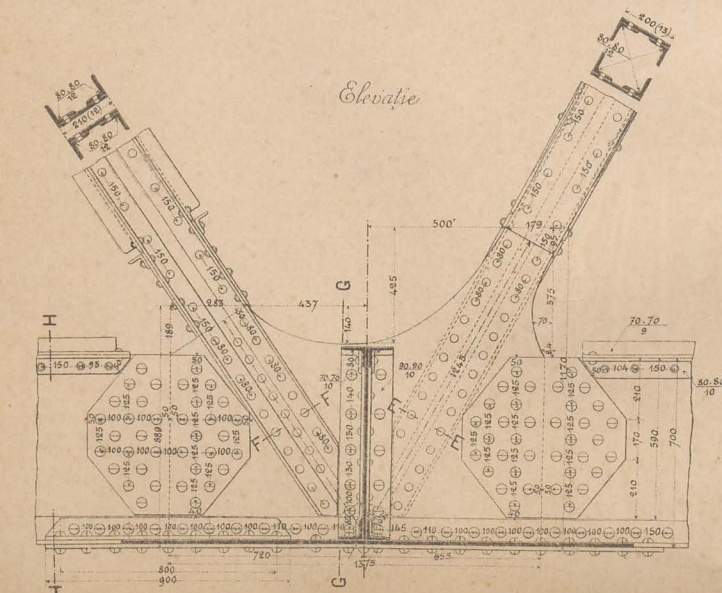

Secțiunea HH      Secțiunea GG

Secțiunea PP      Secțiunea RR

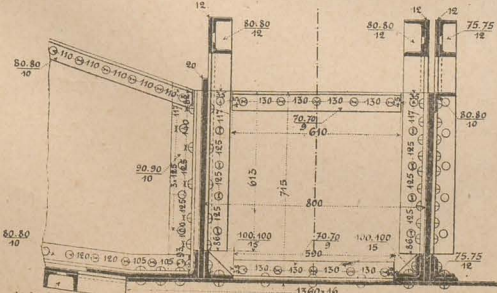
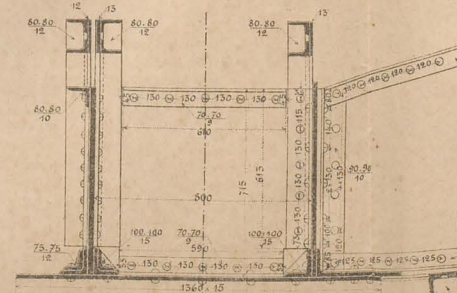

N. N° 5

NODURILE N° 7

DETALII DE IMBINARI

NODURILE N° 7

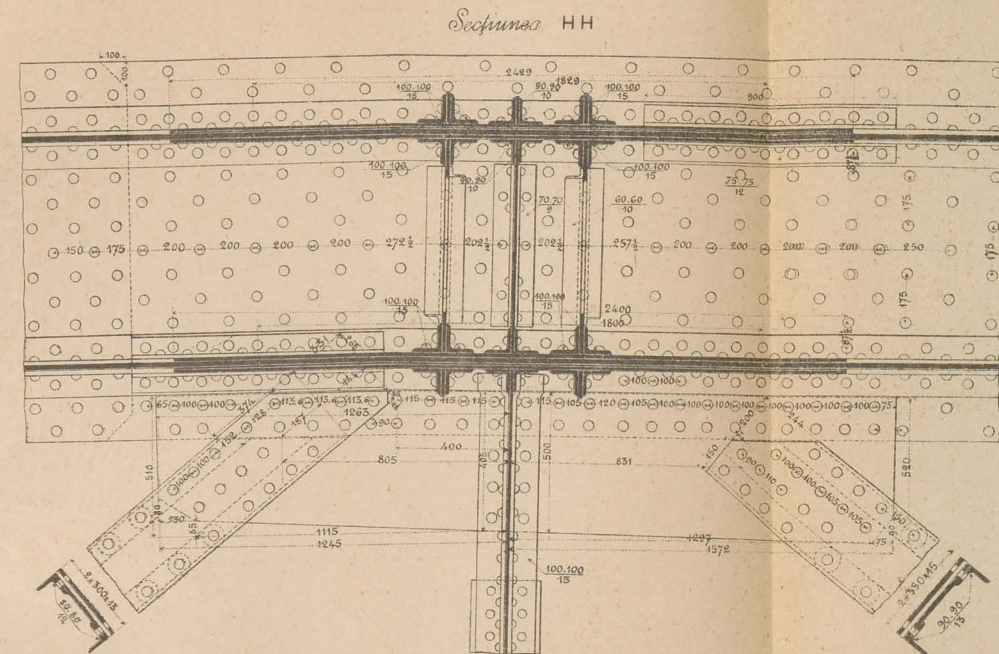
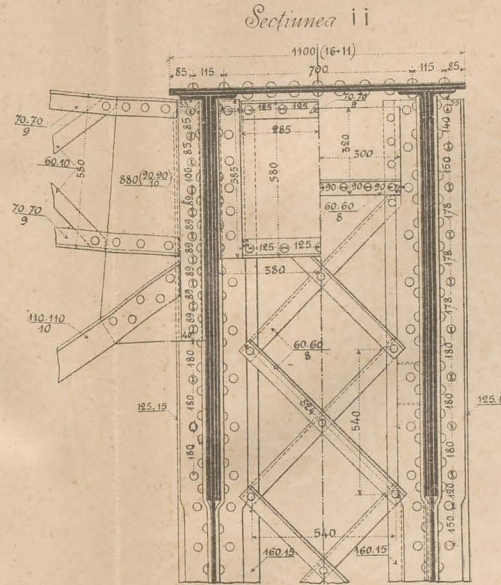
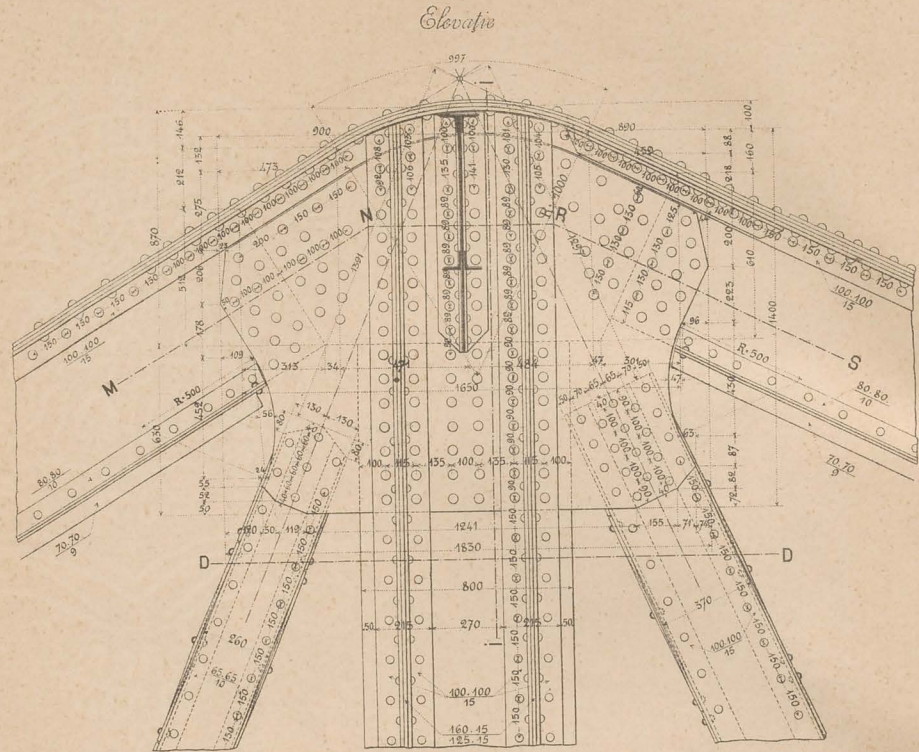

Legenda

- = Nituri de 18<sup>m</sup>
- = Nituri de 20<sup>m</sup>
- = Nituri de 25<sup>m</sup>

Scara



Sectiunea DD

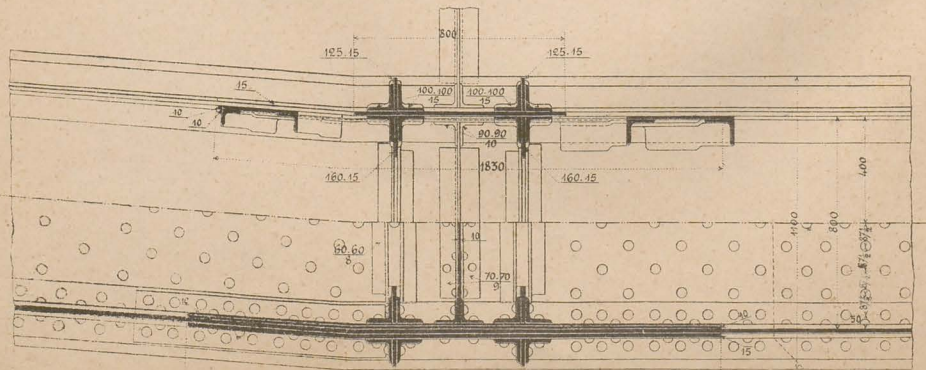

Sectiunea P'P

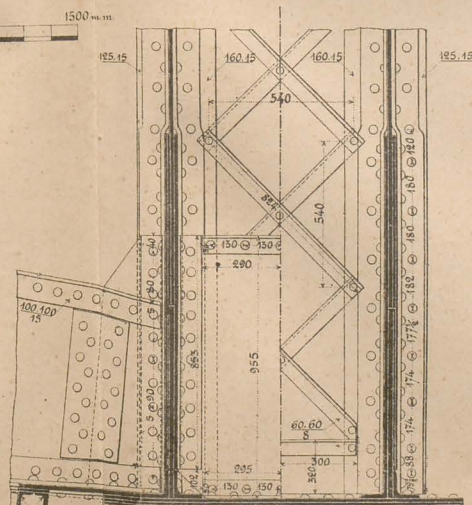

Elevatie

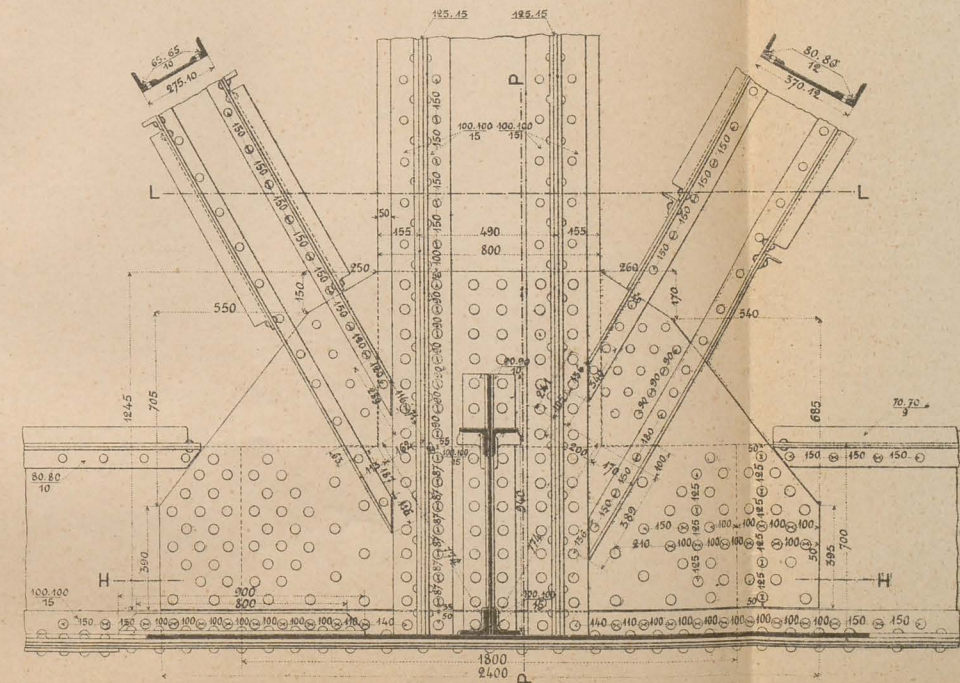

Sectiunea MNRS

N. N<sup>o</sup> 6

# POD PESTE DUNARE LA CERNAVODA

## SECTIUNE TRANSVERSALA PRIN MONTANTUL DE 24 METRI INALTIME

NODUL N<sup>o</sup> 7

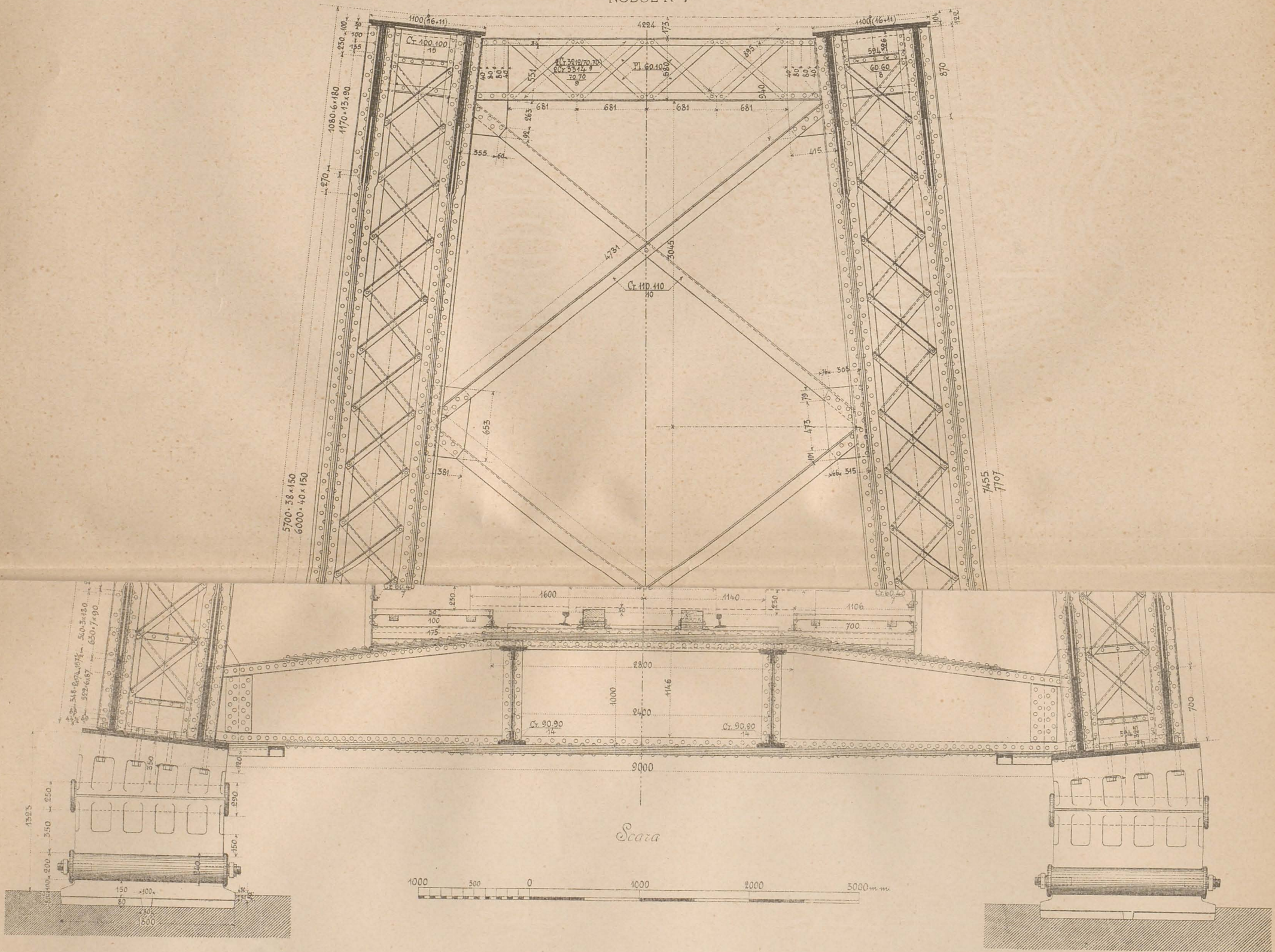

No. \_\_\_\_\_  
 BIBLIOTECA CENTRALĂ  
 S.A. AUTONOMĂ S. R.

POD PESTE DUNARE LA CERNAVODA

SECTIUNE TRANSVERSALA PRIN MONTANTUL DE 24 METRI INALTIME

NODUL N° 7

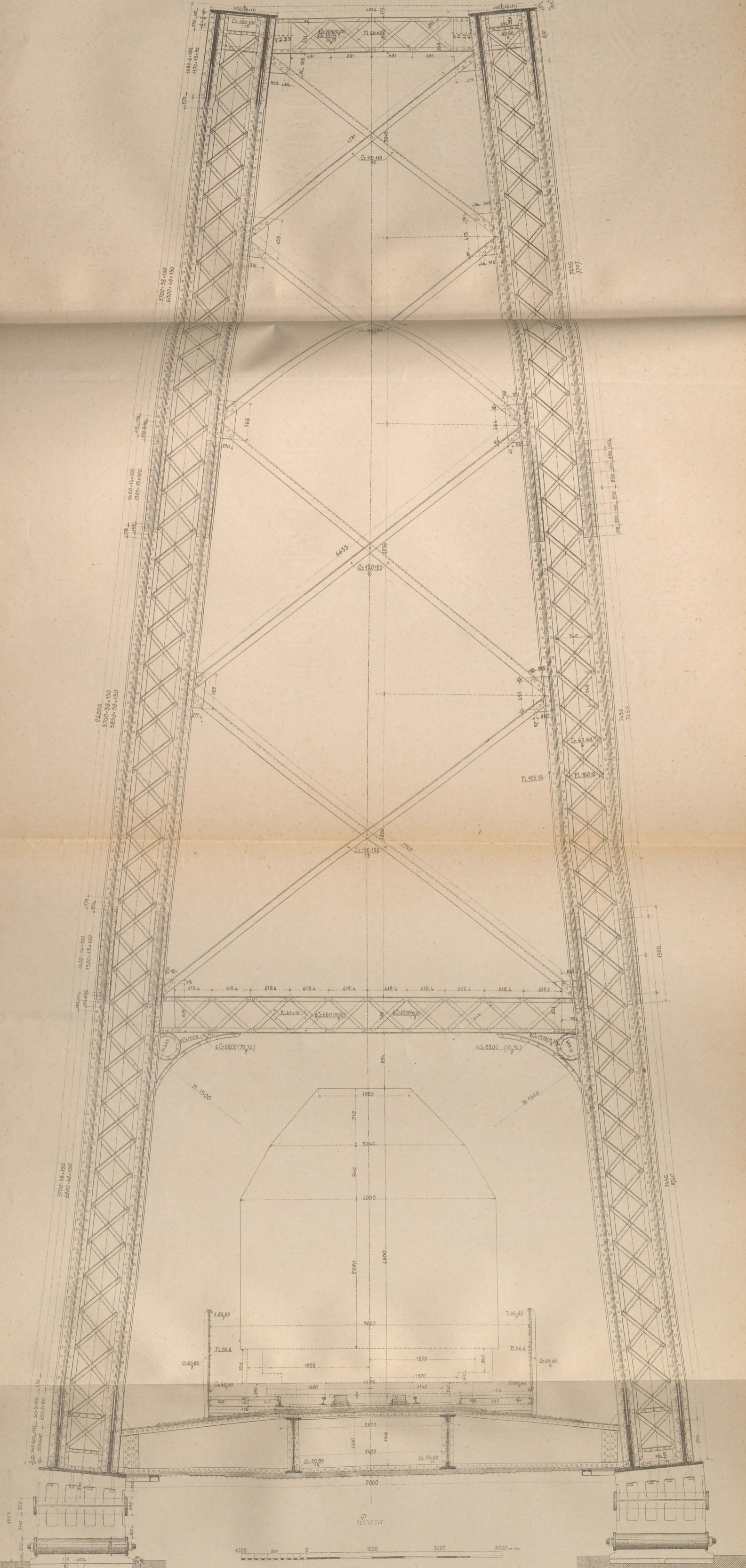



POD PESTE DUNARE LA CERNAVODA  
SECTIUNE TRANSVERSALA PRIN MONTANTUL DE 24 METRI INALTIME

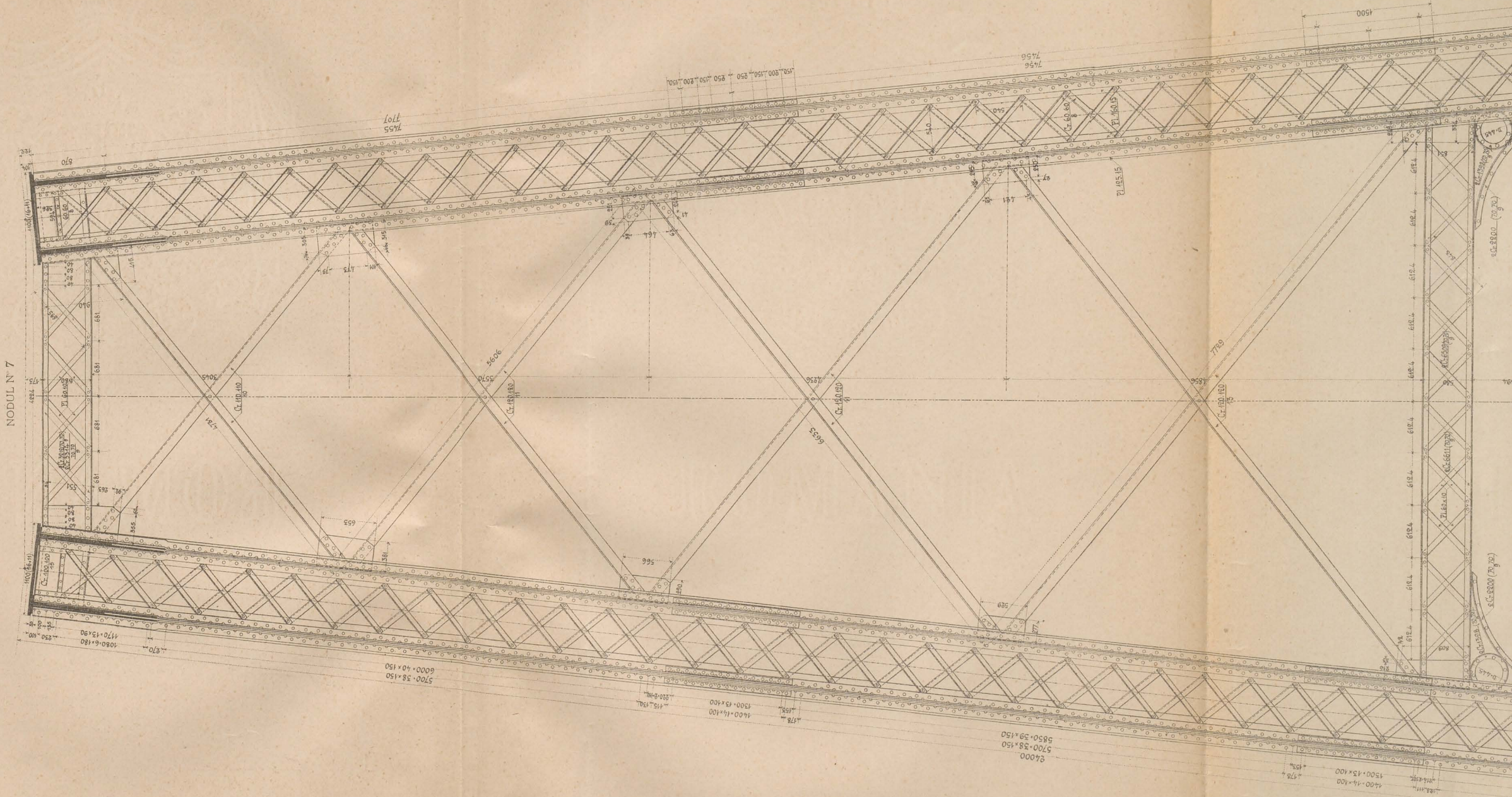



DETAIUL GRINZILOR TRANSVERSALE

CONSTRUCTIA LONGRINELOR

NODUL NO. 6

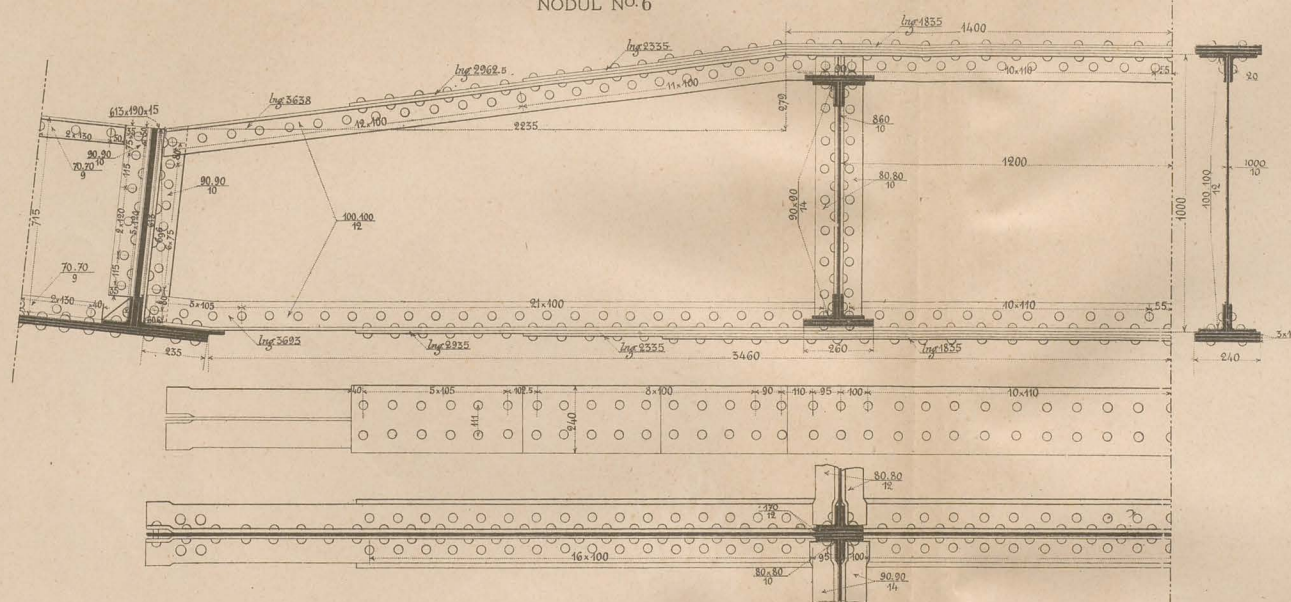

NODUL NO. 7

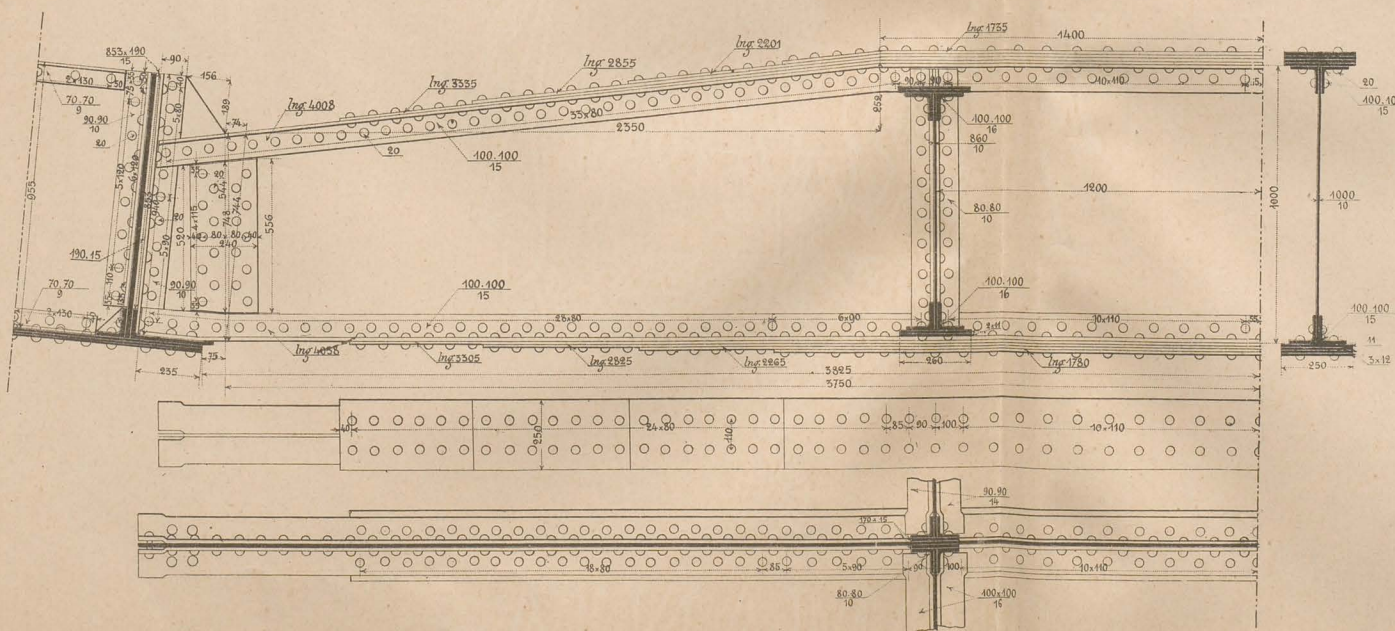

PANOUL NO. 7

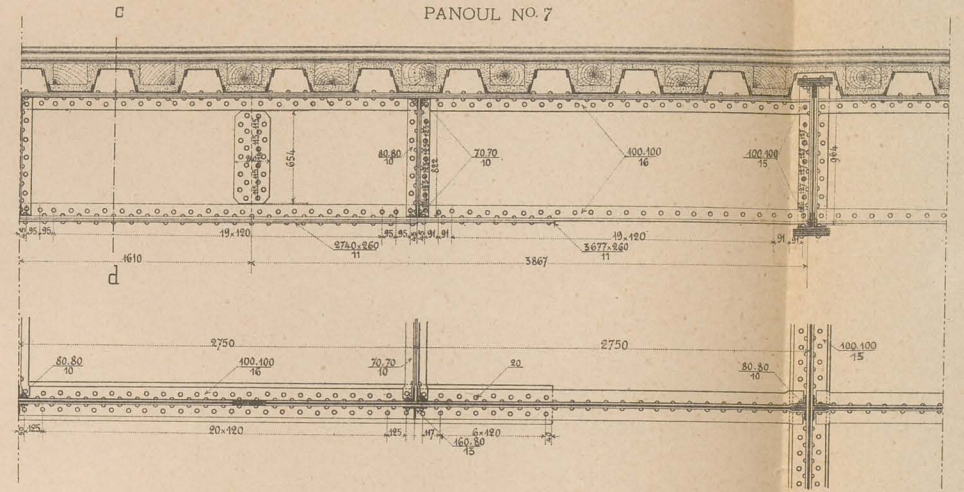

Secțiunea cd

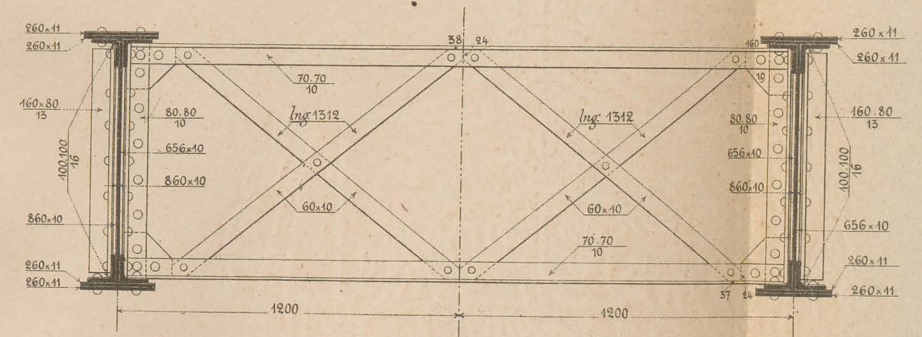

Scara construcției longrinelor

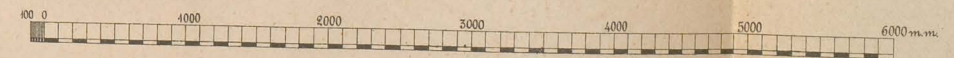

Scara detaliului grinzelor transversale și a Secțiunii cd

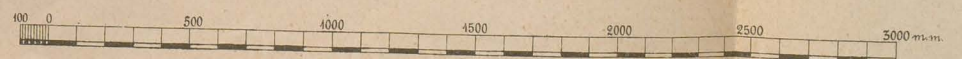

# POD PESTE DUNARE LA CERNAVODA

## REZEMELE LA CAPETELE CONSOLELOR

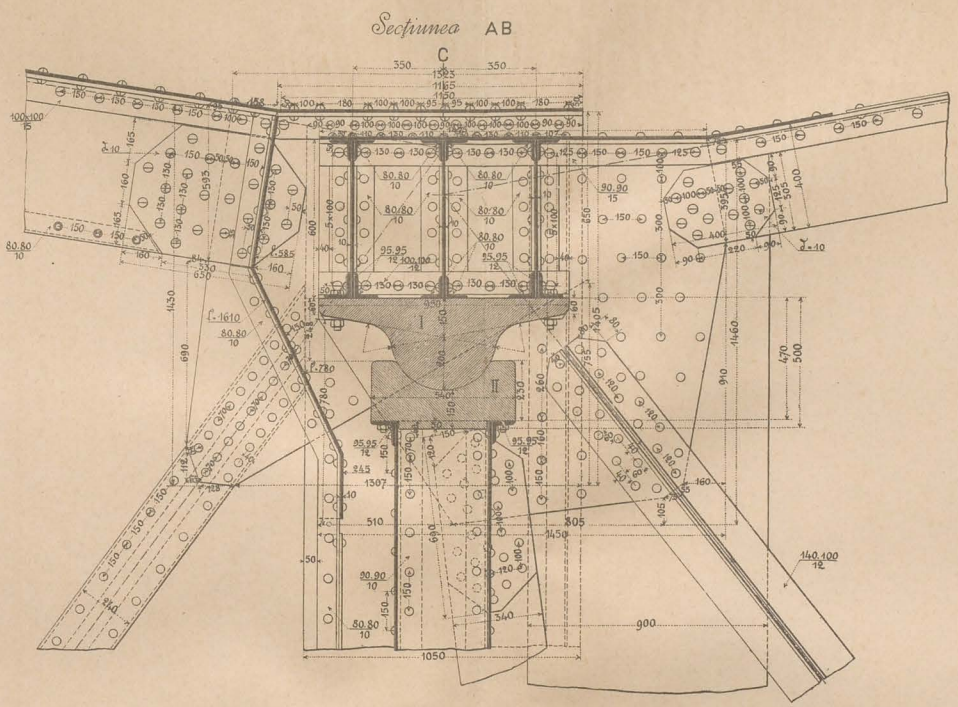
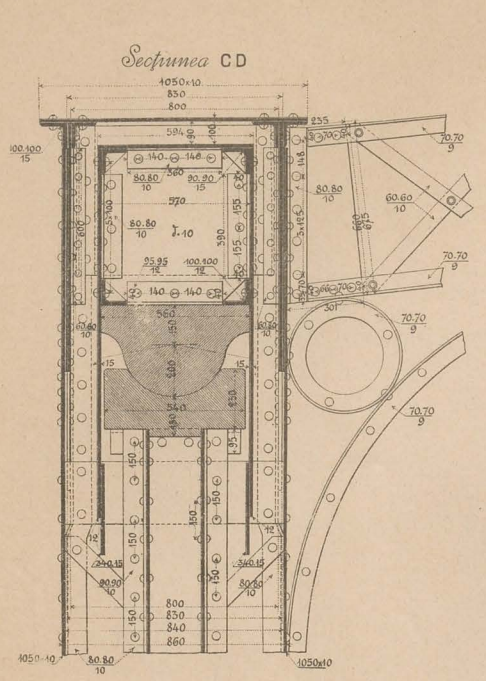

TALPA GRINDEI PARABOLICE IN DREPTUL PENDULEI

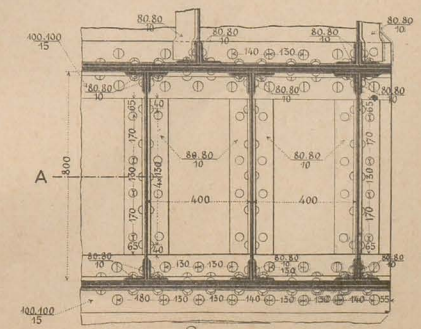
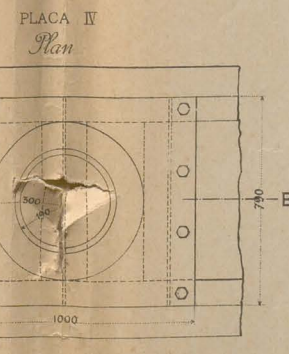
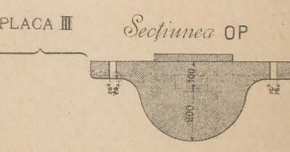
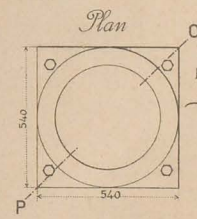
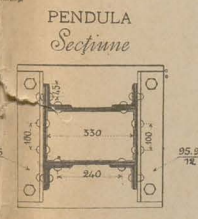
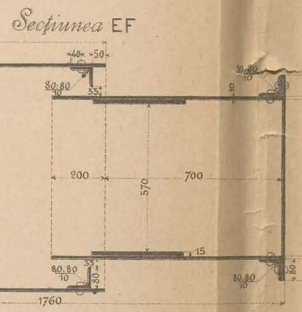
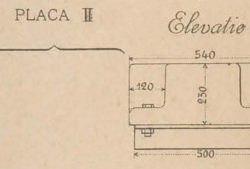
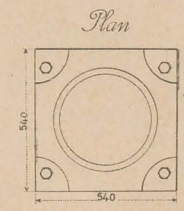
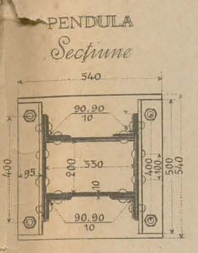
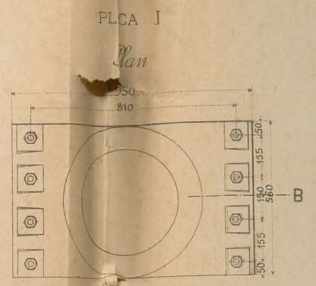
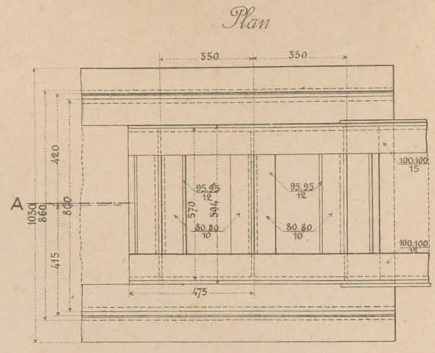

Scara

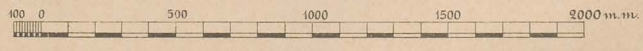

Legenda

- = Nituri de 18 mm.
- = Nituri de 20 mm.
- = Nituri de 25 mm.

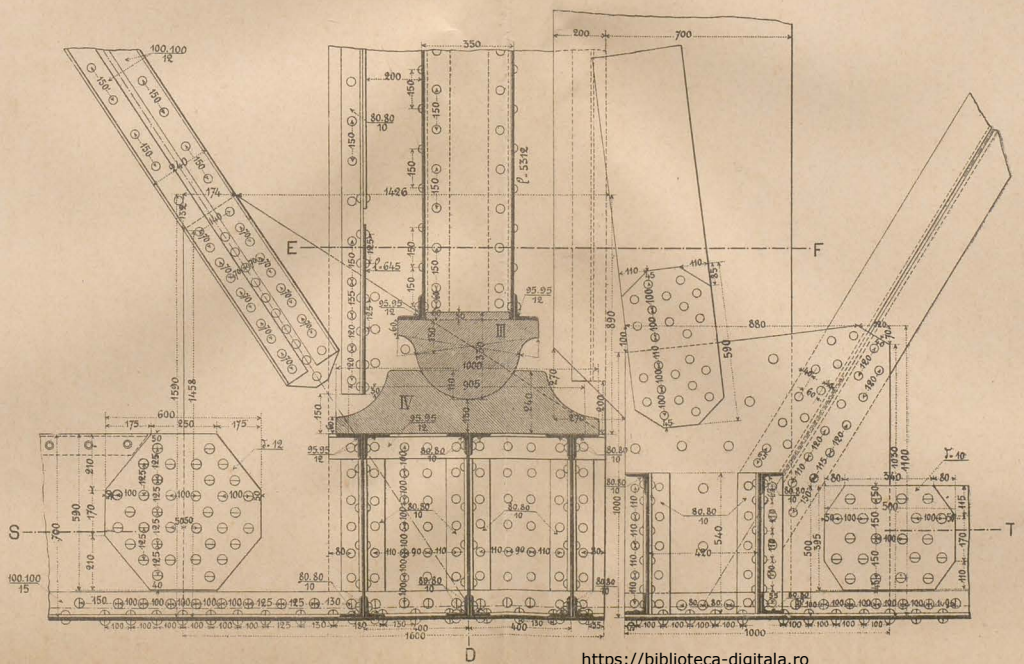
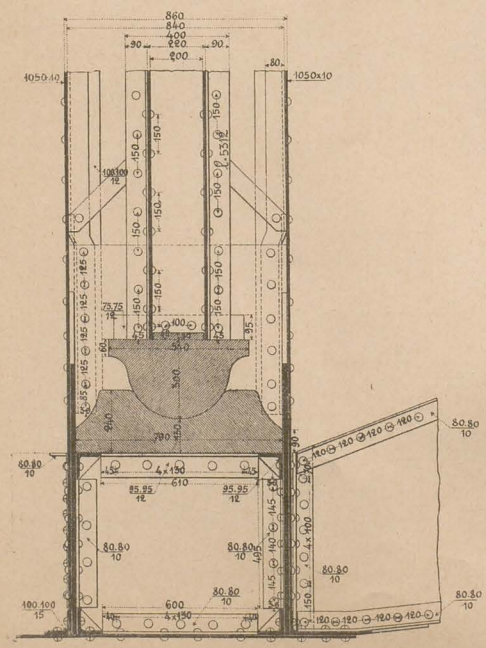

APARATELE DE REZEM PE PILE

REZEMUL MOBIL

REZEMUL FIX

Elevatie  
Secțiune prin A B

Vedere laterală

Secțiune prin C D

Secțiune prin G H

Vedere laterală

Secțiune prin E F

Elevatie

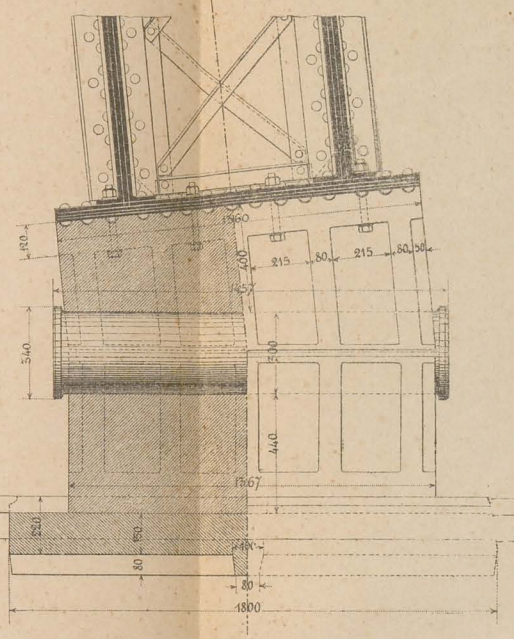
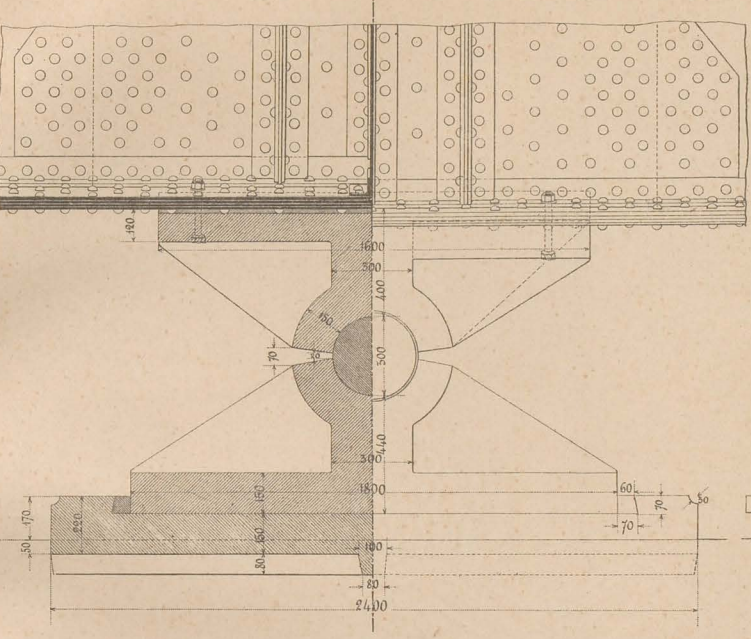
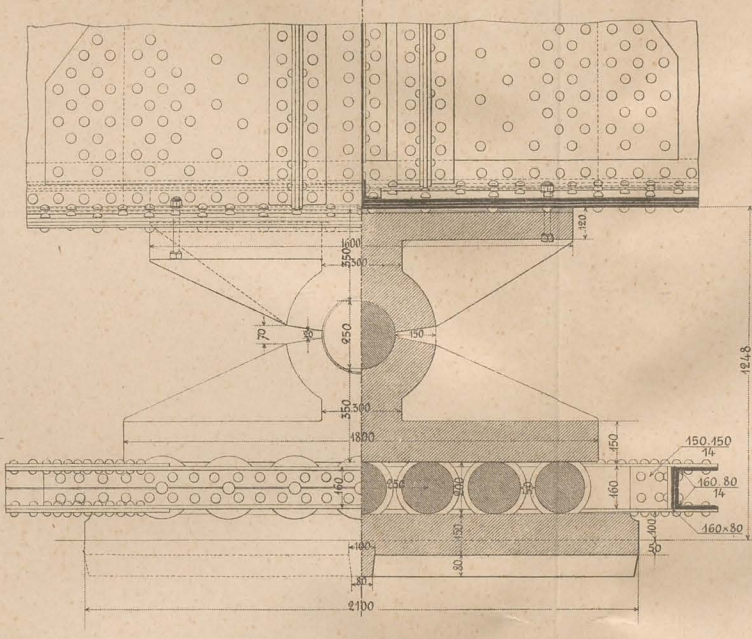
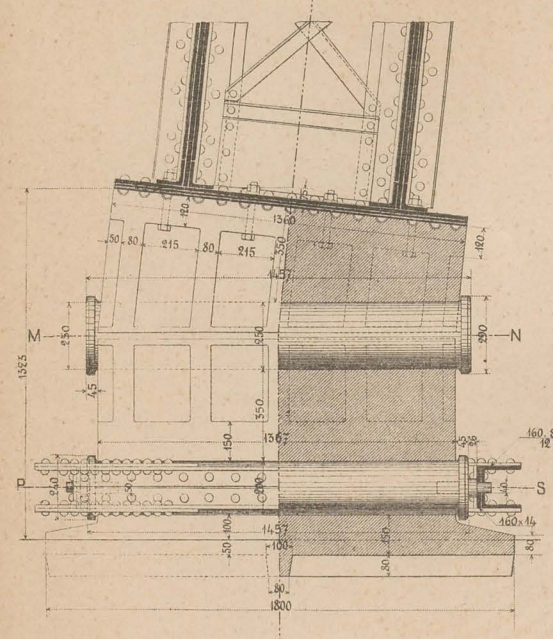

Planul plăcii superioare

Secțiune horizontală prin M N și P S

Planul plăcilor inferioare

Detaliul capului unui rulou

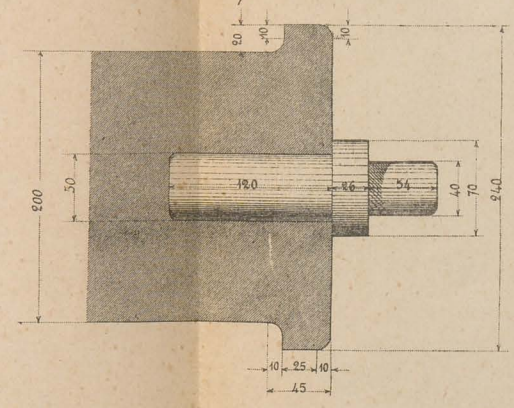
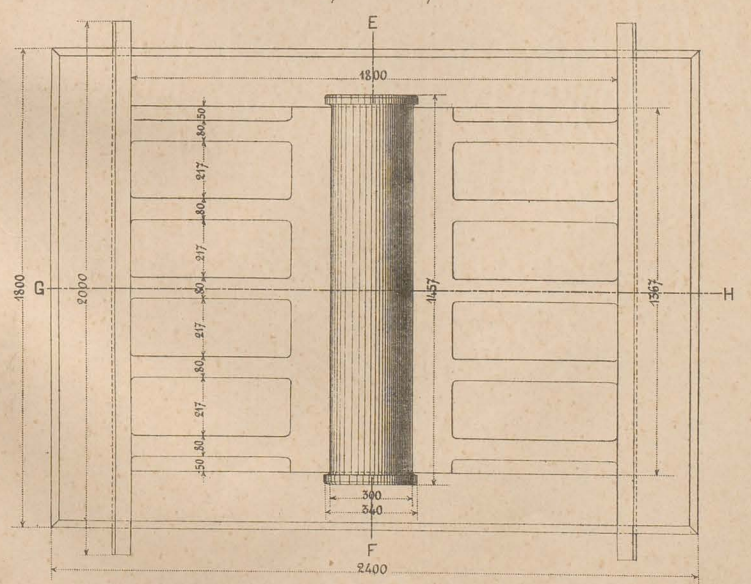
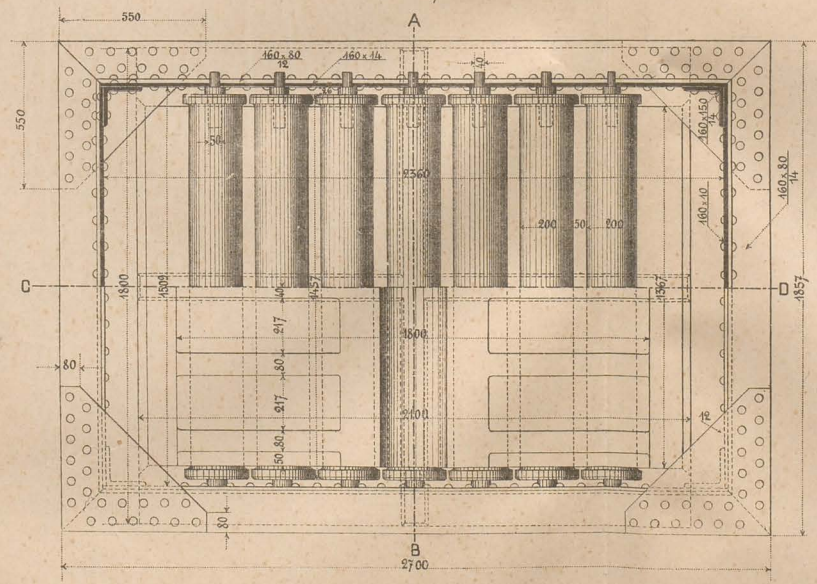
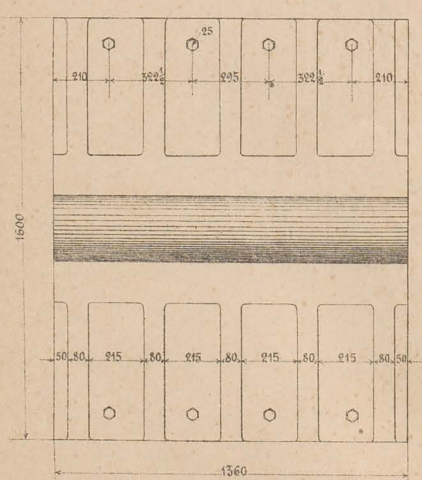

# POD PESTE DUNARE LA CERNAVODA

## CULEA CERNAVODA

ELEVATIE

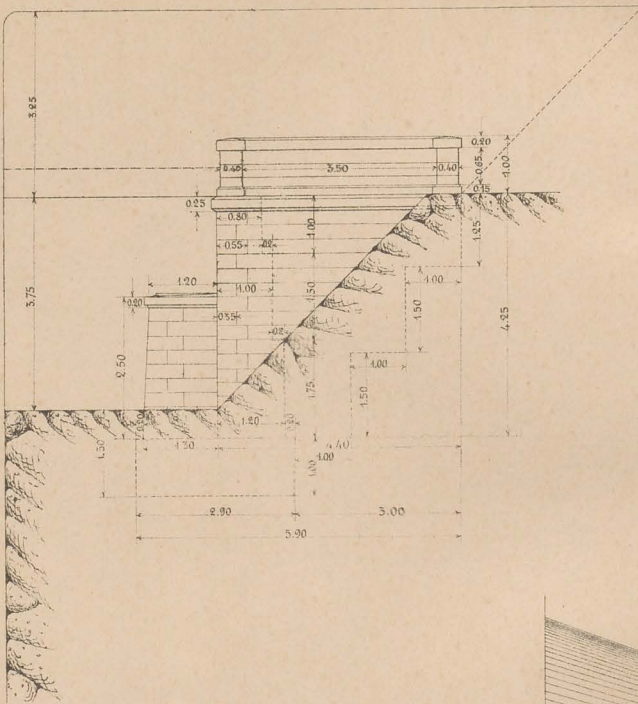

SECTIUNE LONGITUDINALA

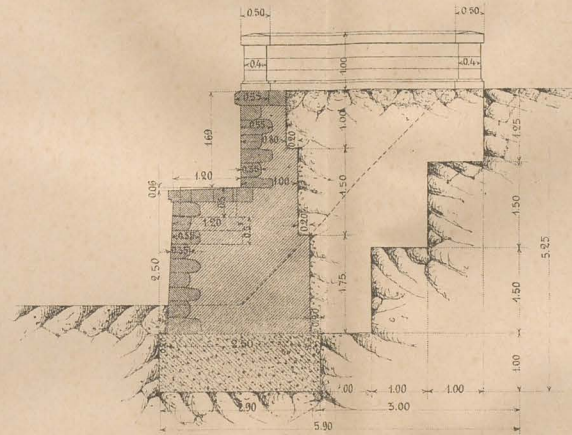

VEDERE DIN FAȚA

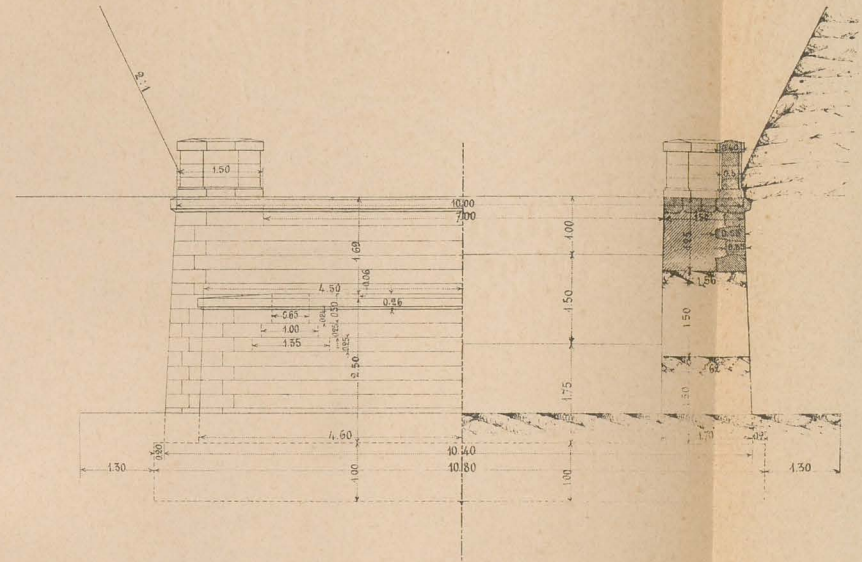

SECTIUNE TRANSVERSALA

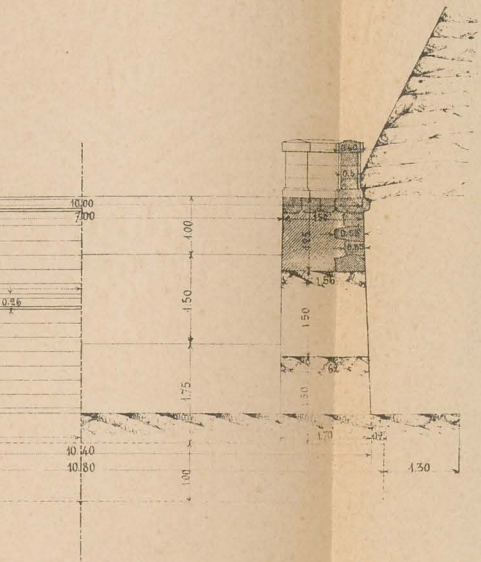

PLAN

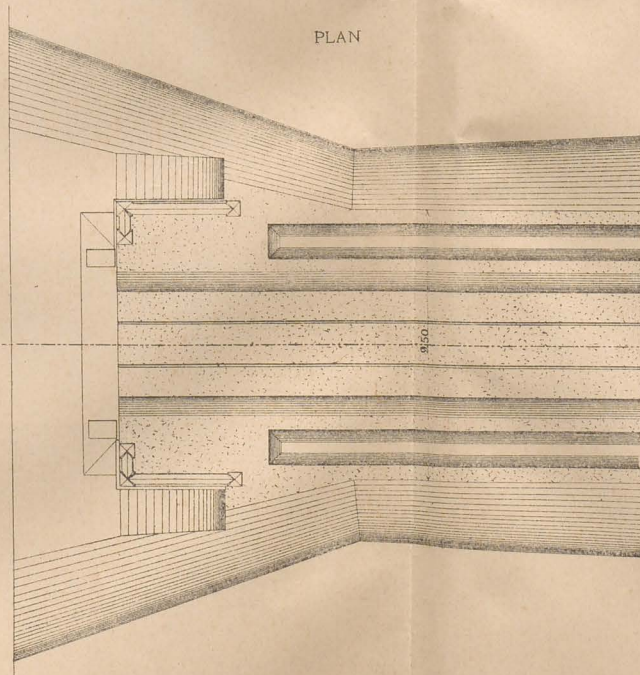

PLAN

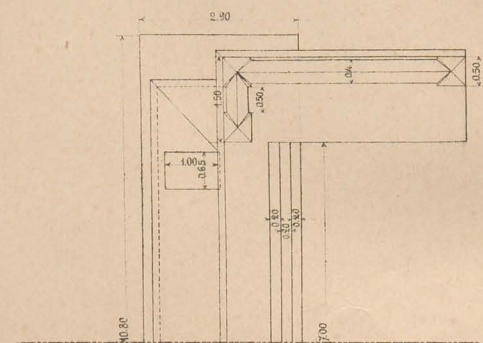

SĂPĂTURĂ ÎN STANCA

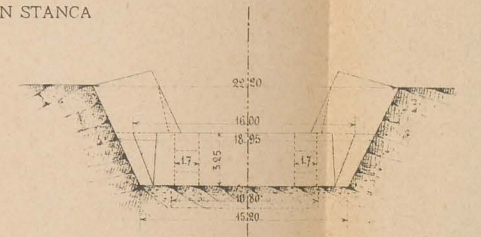
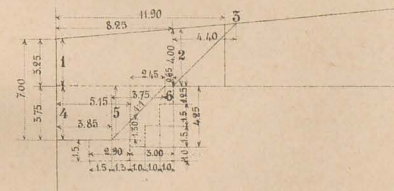

Scara săpăturii în stâncă



Scara planului

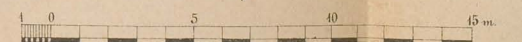

Scara desenei

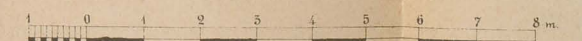

PILA CULEE

PILA LATERALA

VEDERE AMONTE

ELEVATIE

SECȚIUNE TRANSVERSALA

SECȚIUNE NORMALA

SECȚIUNE TRANSVERSALA

ELEVATIE

VEDERE AMONTE

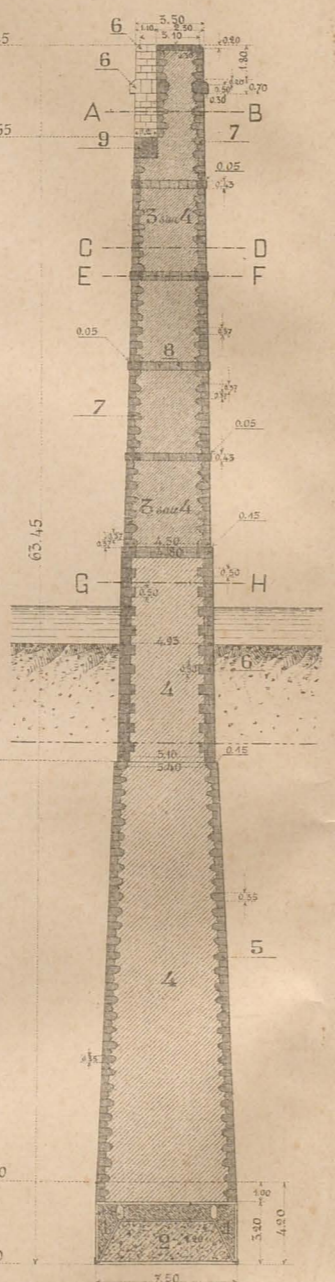
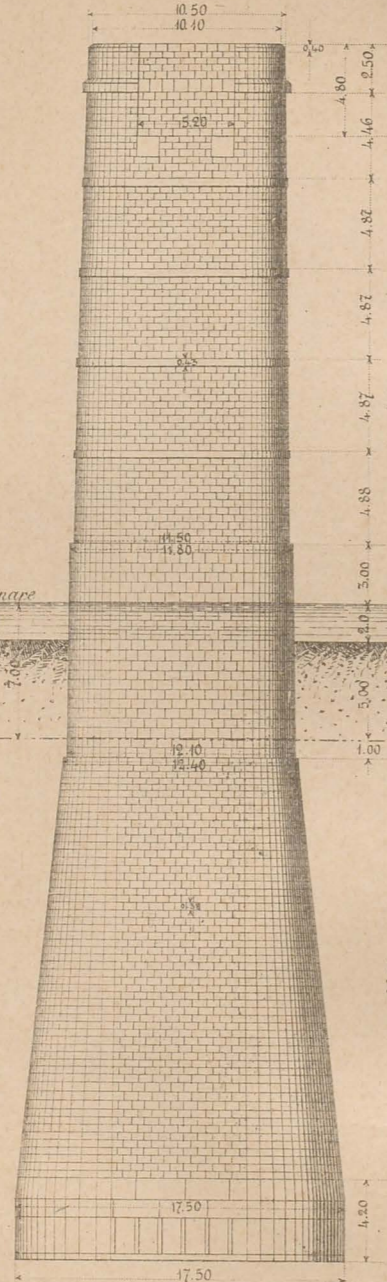
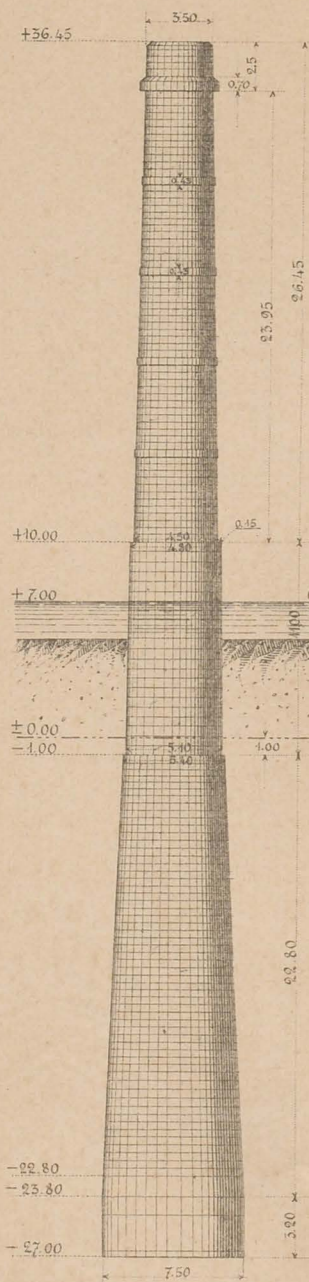

LT  
PRIN SPARGHET

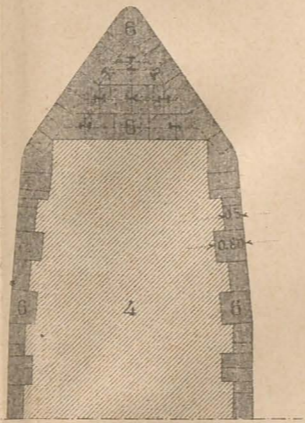

LEGENDA

1. Beton cu mortar de ciment
2. Beton cu mortar de var hydraulic
3. Zidarie de moelone brute cu mortar de ciment
4. Zidarie de moelone brute cu mortar de var hydraulic
5. Zidarie de parament de moelone (smulles) cu mortar de var hydraulic
6. Zidarie de piatra cioplita de granit cu mortar de ciment
7. Zidarie de parament de moelone de aparut cu mortar de var hydraulic
8. Zidarie de piatra cioplita cu mortar de cim.
9. Cusineti de piatra cioplita

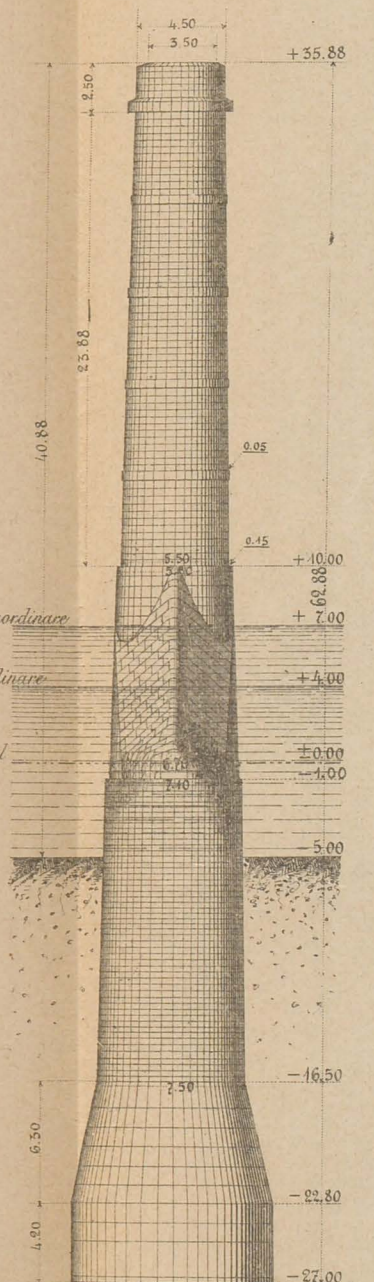
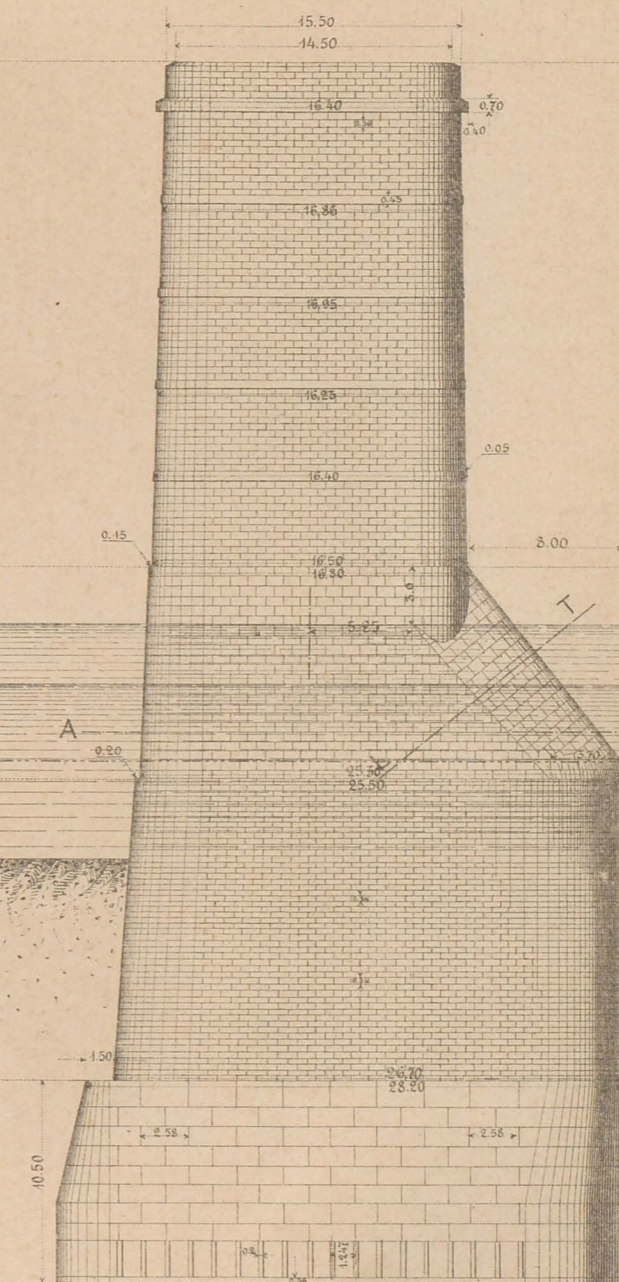
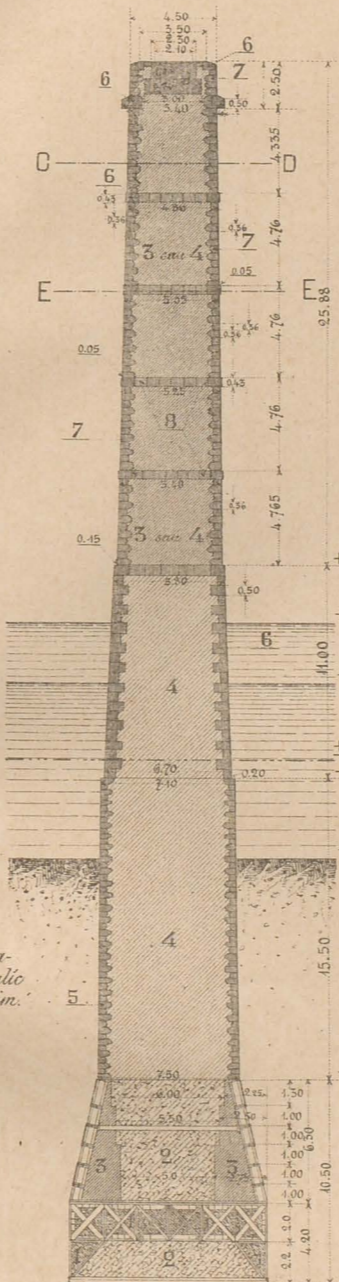

SECȚIUNI HORIZONTALE PRIN

AB GH

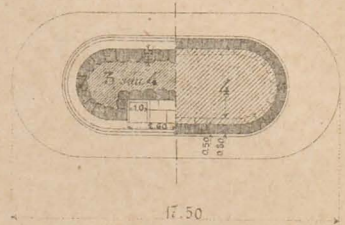

PLAN

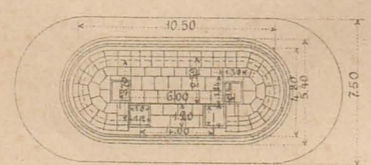

SECȚIUNI HORIZONTALE PRIN

CD EF

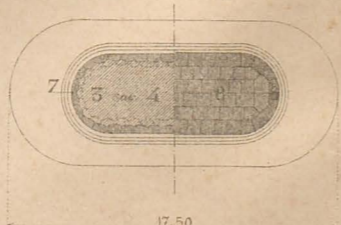

SECȚIUNE HORIZONTALA AB  
PRIN SPARGHET

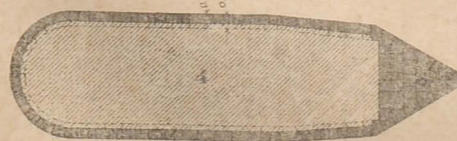

PLAN

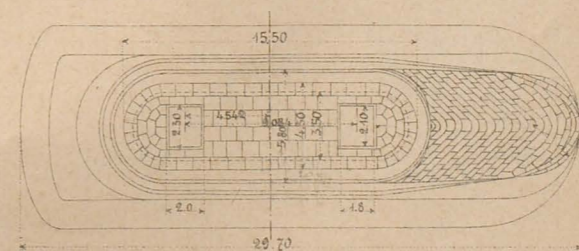

SECȚIUNI HORIZONTALE PRIN

CD EE

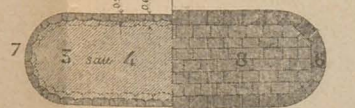

Scara secțiunii normale prin sparghet

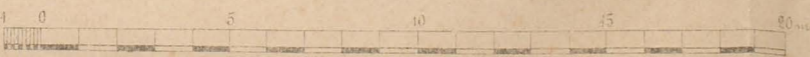

Scara desenelelor

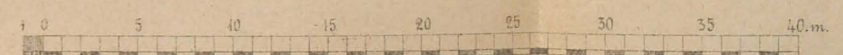

# POD PESTE DUNARE LA CERNAVODA

## PILA SUB MONTANTUL DE 81 METRI

VEDERE AMONTE

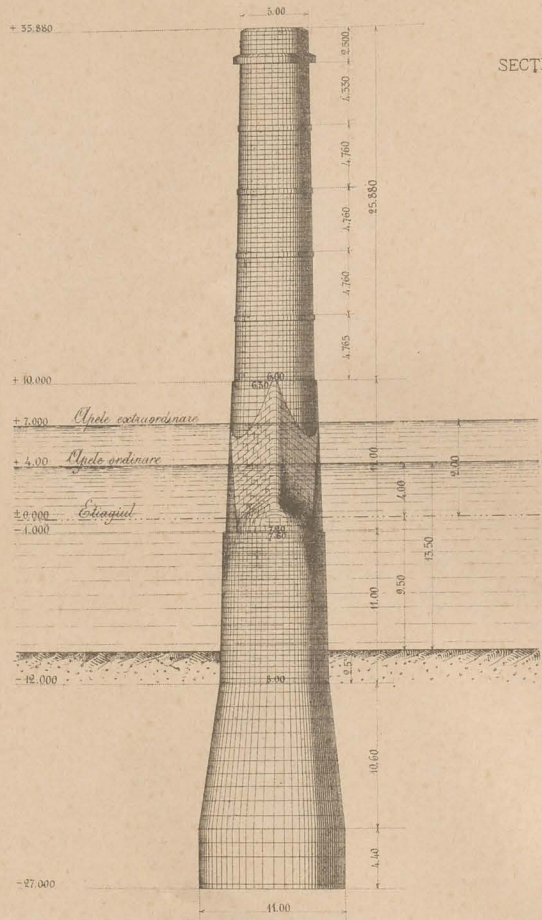

SECȚIUNE NORMALĂ PRIN SPARGHET

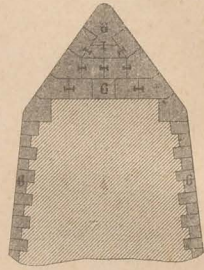

ELEVATIE

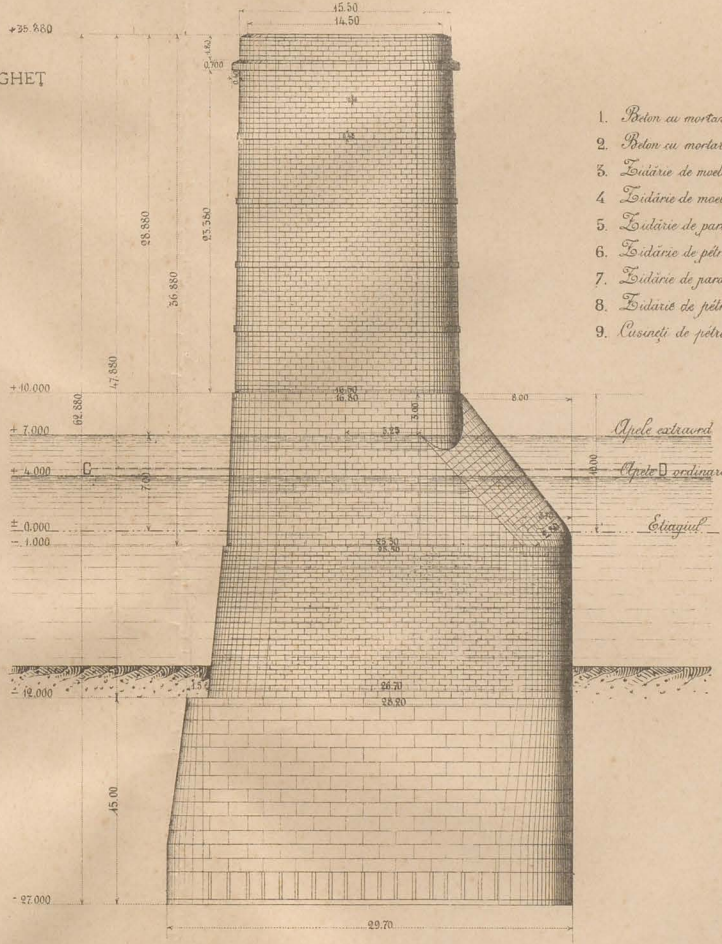

LEGENDA

1. Beton cu mortar de ciment
2. Beton cu mortar de var hidroalic
3. Lutărie de molone brute cu mortar de ciment
4. Lutărie de molone brute cu mortar de var hidroalic
5. Lutărie de parament de molone (smiltes) cu mortar de var hidroalic
6. Lutărie de piatră cioplită de granit cu mortar de ciment
7. Lutărie de parament de molone la apparat cu mortar de var hidroalic
8. Lutărie de piatră cioplită cu mortar de ciment
9. Covoști de piatră cioplită

SECȚIUNE TRANSVERSALĂ

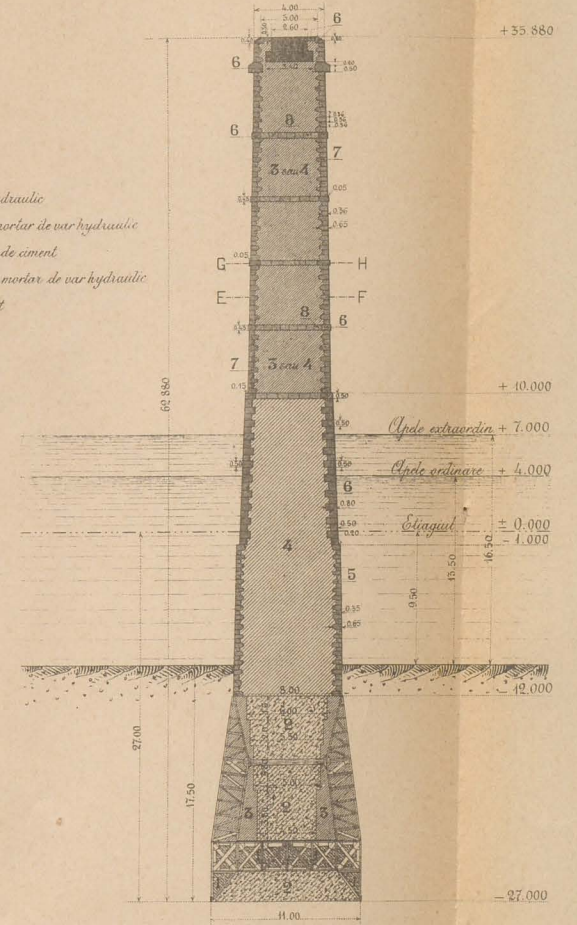

SECȚIUNE HORIZONTALĂ CD  
PRIN SPARGHET

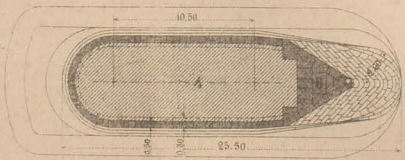

PLAN

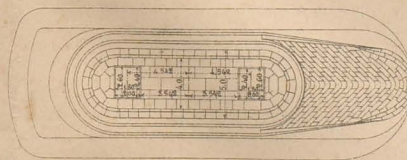

SECȚIUNI HORIZONTALE PRIN  
EF GH

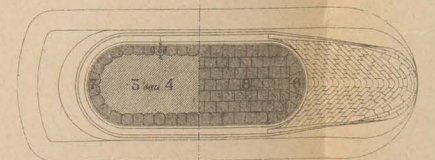

Scara secțiunii normale prin sparghet

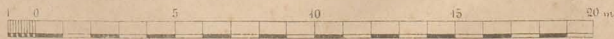

Scara desenului

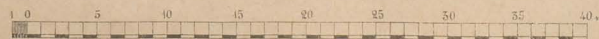



SECȚIUNE TRANSVERSALA

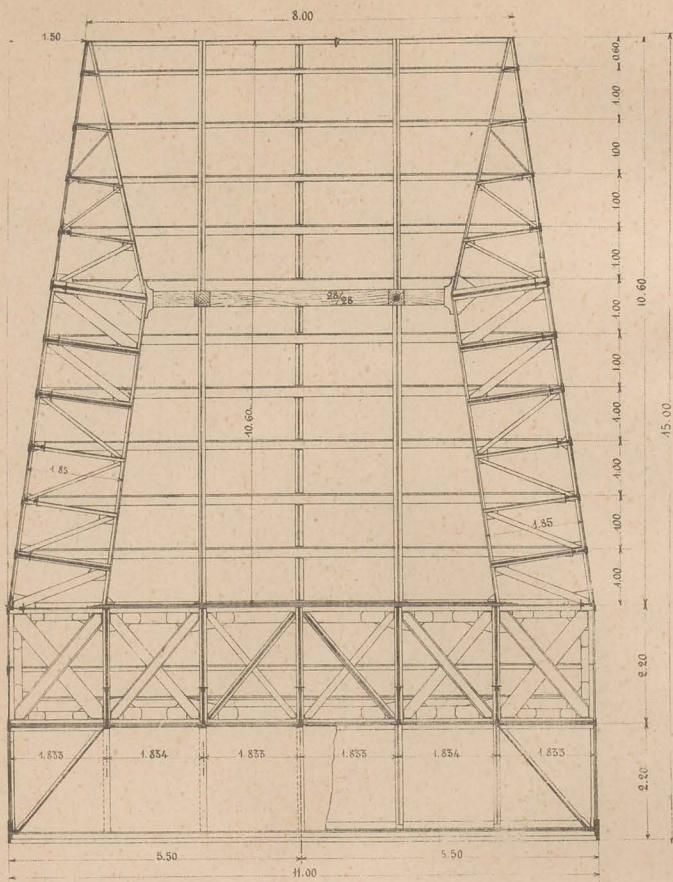

ELEVATIE SI SECȚIUNE LONGITUDINALĂ

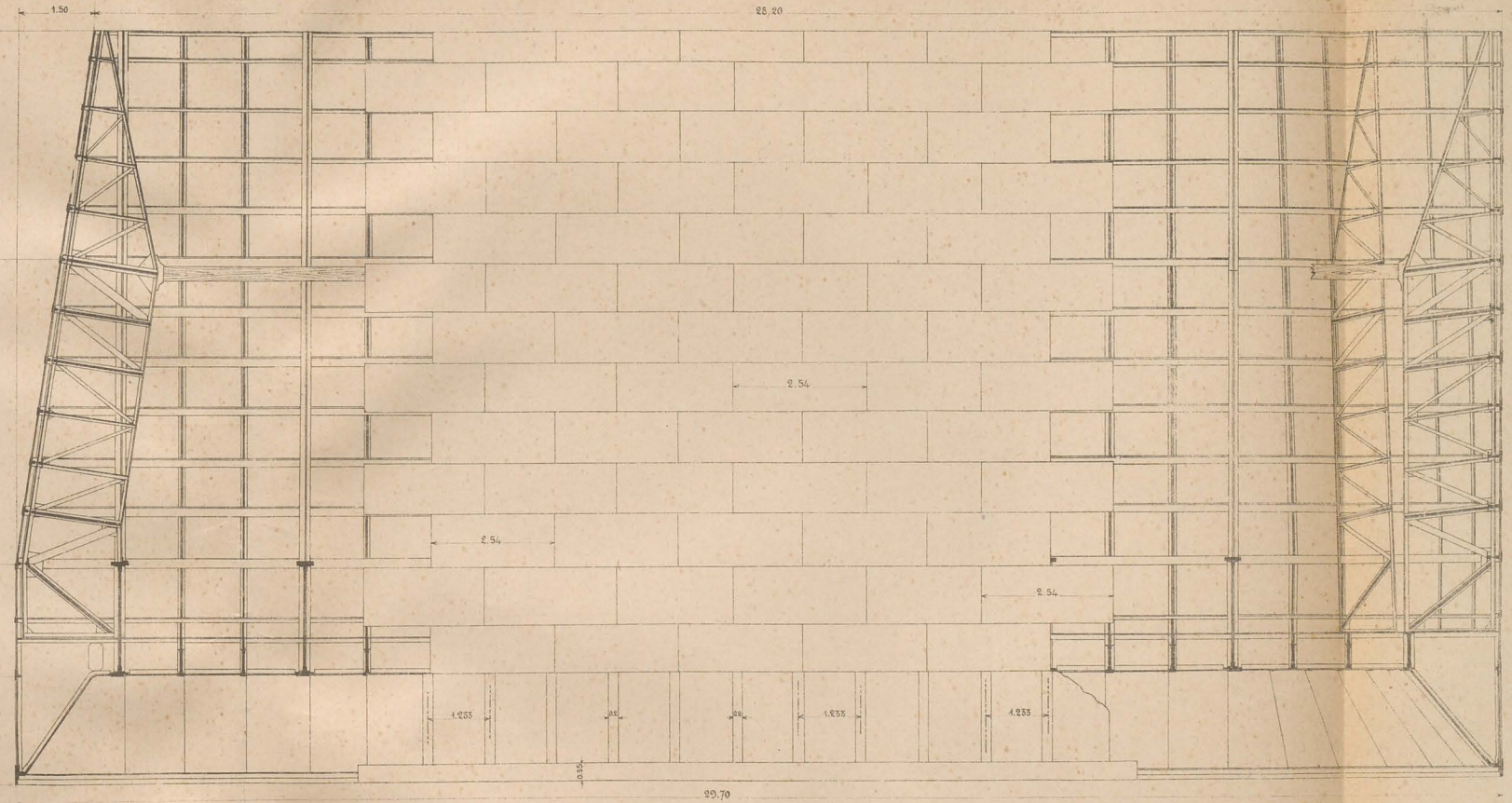

CHESONUL PILELOR CENTRALE

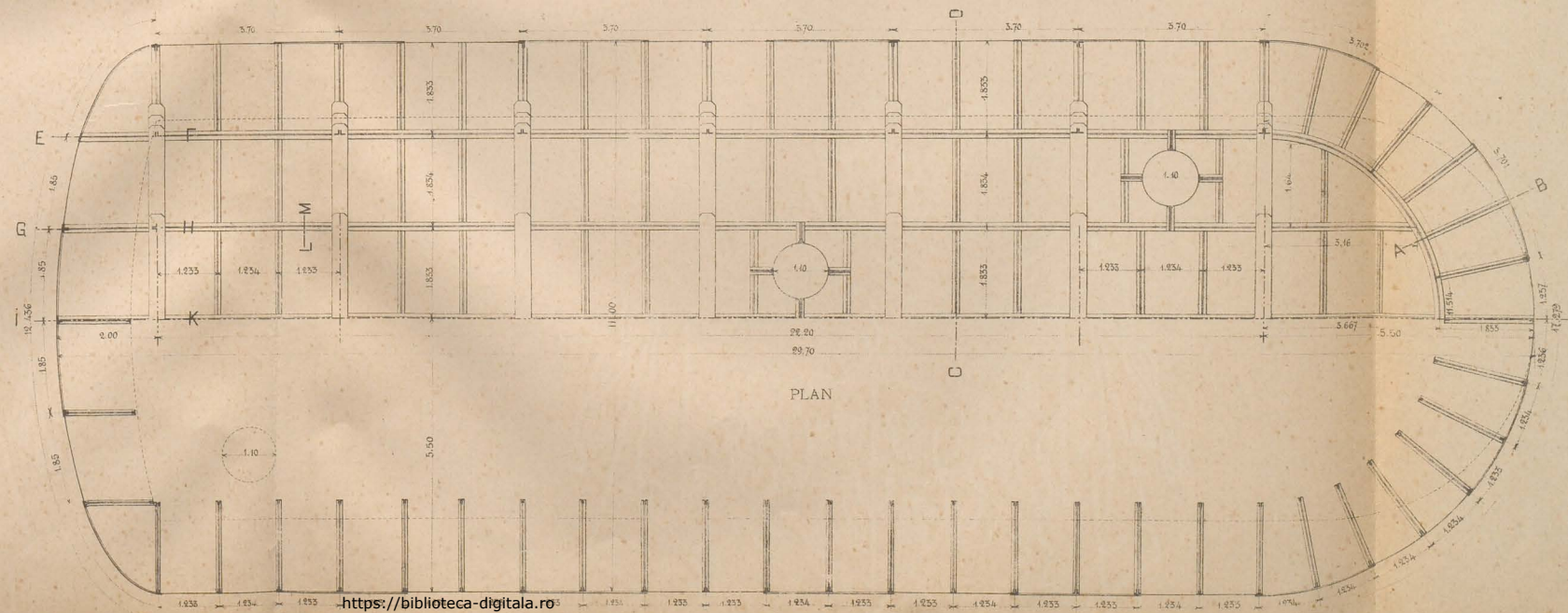

Scara Secțiunilor Elevații  
și a  
Planului

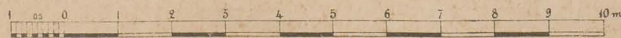

PROIECTUL CHESONULUI PILEI N° 1

VEDERE EXTERIORA

VEDERE INTERIORA

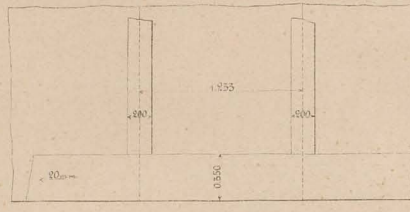
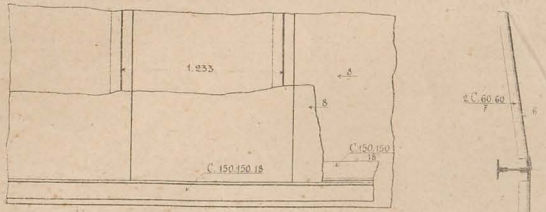

Secțiunea AB

Secțiunea CD

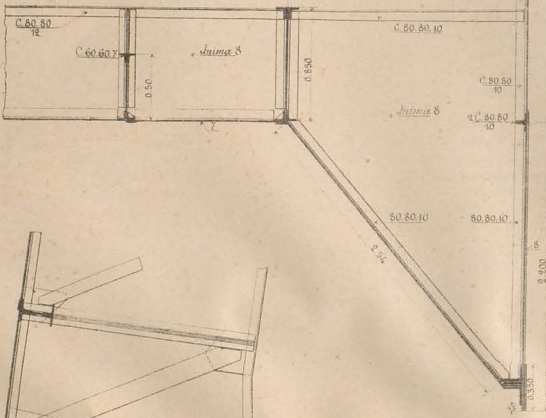

SABOTU



Secțiunea ab cd

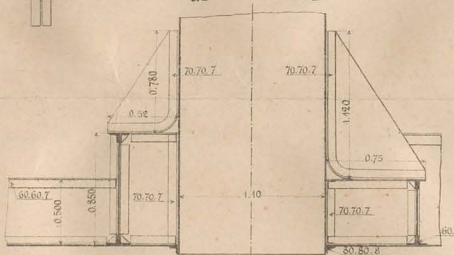

Secțiunea GH

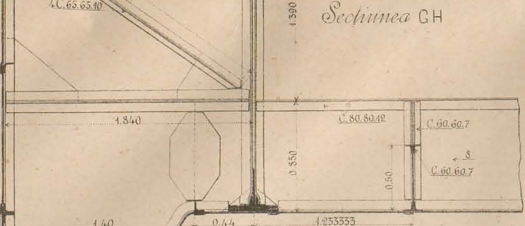

PLANUL COȘULUI

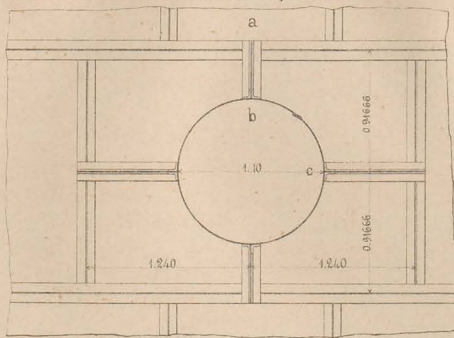

Secțiunea EF

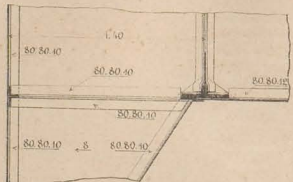

Secțiunea LM

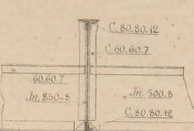

Secțiunea IK

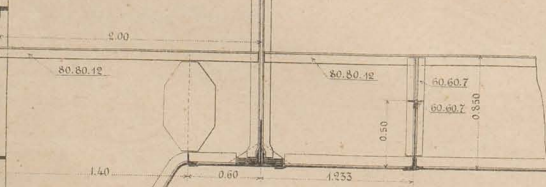

GRINDA PRINCIPALA A BATARDOLUI

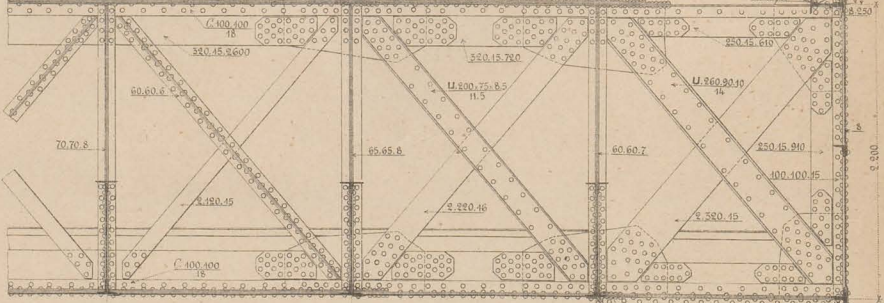

DETALII

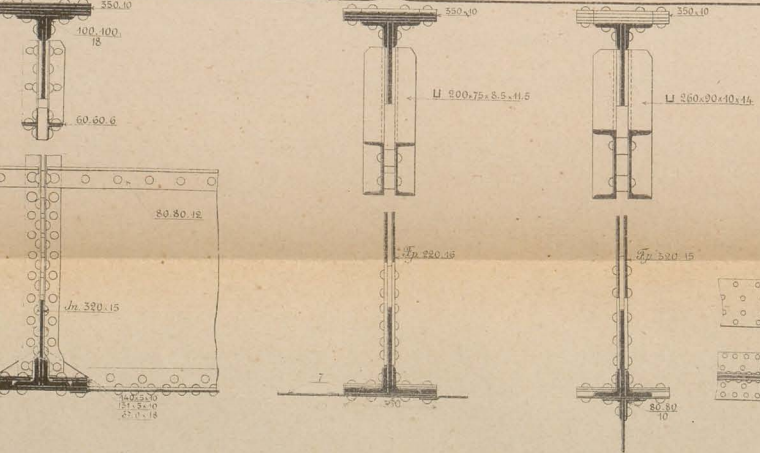

Plan

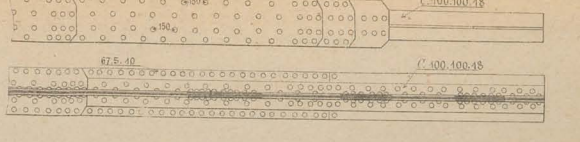

# POD PESTE DUNARE LA CERNAVODA

### ELEVATIE

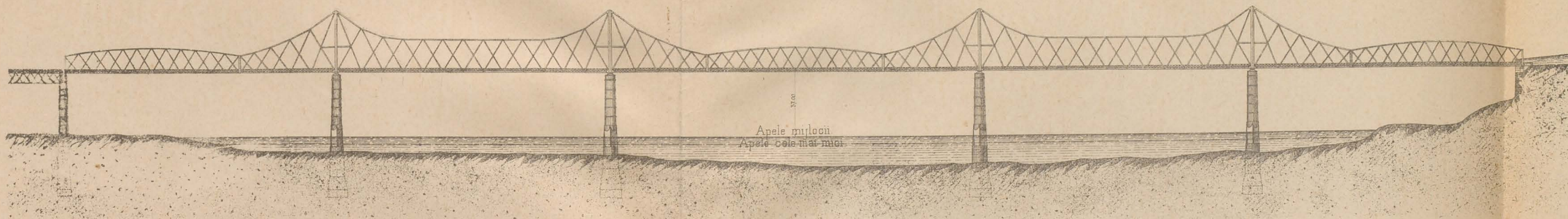

### PLAN

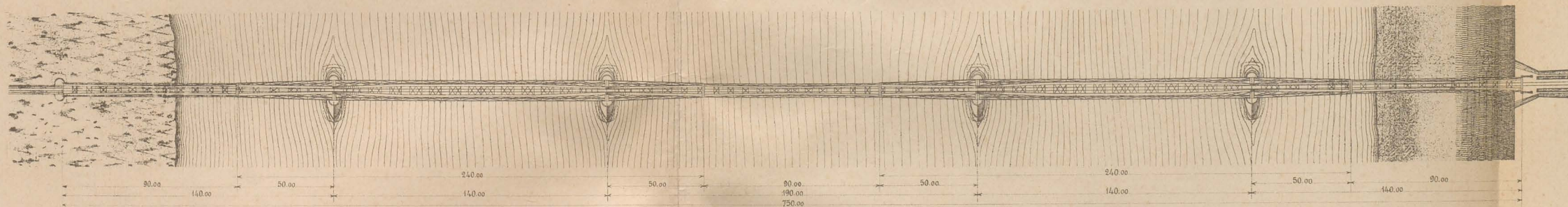

### SECȚIUNE TRANSVERSALĂ

PRIN

MIJLOCUL GRINDEI CONSOLE

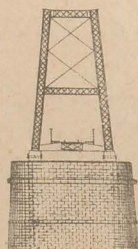

### SECȚIUNI TRANSVERSALE

PRIN

MONTANT

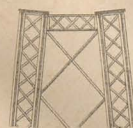
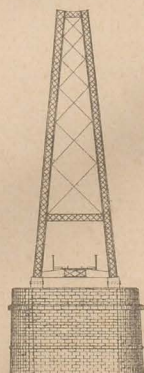

DETALIU

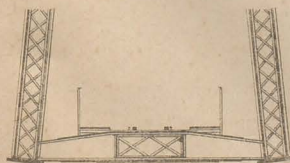

### Scara Elevatiei si Planului

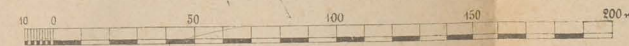

### Scara Secțiunilor transversale

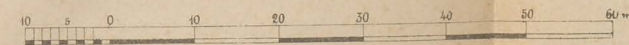

### Scara detaliului

